



alpinespas™

SPA POOL

OWNERS MANUAL



**SUBSCRIBE &
SAVE
UP TO 30%
ON AUTOSHIP PRODUCTS**



DON'T WASTE TIME, SHOP ONLINE

WWW.SPASUPPLIES.CO.NZ | WWW.SPASUPPLIES.COM.AU



Scan to view all of our products



1 Introduction	4
2 Welcome / Spa Pool Record & Warranty	5
3 Important Safety & Operating Instructions	6
Placing the spa pool	9
4 Installation Instructions	10
Spa pool contents	10
Assembling the accessories	10
Pre-fill procedure	11
Filling the spa pool	12
Electrical wiring / powering up	15
5 Startup & Refill Procedure	18
Installing the filter cartridges	18
Switching on & heating up	21
Balancing & sanitising the water	21
6 Spa Pool Usage Guide & Tips	23
Topside control panel quick guides	23
Spa pool operation	28
7 Getting to Know Your Spa Pool	34
Spa pool overview by model	34
Spa pool parts labeled	68
Pressure diverter & air venturi valves	71
Waterfall control	71
LED lights	72
Jets	72
8 Spa Pool Care & Maintenance	74
Opening the panels	74
Draining the spa pool	75
Cleaning the filters	76
Cleaning the acrylic shell	76
Cleaning & maintaining the cabinet	77
Caring for the spa pool cover	77
Cleaning the jets	78
Performing a pipe clean	78
Leaving the spa pool short term	79
Leaving the spa pool long term	80
Cleaning schedule / checklist	81
9 Service Information	82
Pump maintenance	82
Barrel union maintenance	82
U.V system bulb replacement	83
Technical support contact	83
Troubleshooting	84

Congratulations!

You are the proud new owner of an Alpine Spa! It is our pleasure to welcome you to the Alpine Spa family. Luxurious hours soaking under the stars whilst enjoying good company and hydrotherapy massage, is now ready and waiting for you every day, all within the confines of your own backyard!

We take exceptional pride in our product and have worked hard to ensure all our spa pools include not only the latest in spa pool technology, but also the absolute best in design, quality and construction. So you can rest assured our products will last you for many relaxing years to come.

Cheers,

The Alpine Spas Team





Welcome

Please take the time to read this entire manual before operating the spa pool. This manual contains important information for the owner and we suggest keeping it in a safe place for future reference. Every effort has been made to ensure the accuracy of this manual, however Alpine Spas reserves the right to change or improve their products and their specifications without notification. If you have any questions about this manual or the spa pool, please contact Alpine Spas for assistance. Please refer to our website for terms & conditions.



The latest version of this owners manual, along with other helpful material can be downloaded from our support page: www.alpinespas.co.nz/support or www.alpinespas.com.au/support

Your Personal Record & Warranty

Spa Pool Details

Please fill in this information below and keep on hand for future reference. Alpine Spas may request this information upon the submission of a service or technical request.

Your name _____

Spa Pool model _____

System Controller SpaNet SV3, SV-SMART, SMARTTOUCH OR SV-MINI _____

Serial number (found on silver cabinet plaque) _____

Date of purchase _____

Date of installation _____



IMPORTANT WARRANTY INFORMATION:

Spa Pool warranty is effective from date of delivery & is not transferable. Please contact Alpine Spas for all information regarding warranty. Warranty may be void due to improper operation, care or negligence. Certain routine water care and general care requirements along with operation guides are found throughout this manual, please read and follow all instructions. Perform routine maintenance as per pages 82-85.



READ AND FOLLOW ALL INSTRUCTIONS!

WHEN INSTALLING AND USING THIS SPA POOL AND ITS ELECTRICAL COMPONENTS, BE SURE TO FOLLOW BASIC SAFETY PRECAUTIONS INCLUDING THE FOLLOWING:

1. WARNING:

To reduce the risk of injury, do not permit children to use this product unless they are closely supervised at all times.

2. DANGER:

Risk of accidental drowning. Extreme caution must be exercised to prevent unauthorized access by children.

3. DANGER:

Risk of injury. Never operate the spa pool if suction fittings are broken or missing.

4. DANGER:

Risk of electrical shock. Do not permit any electrical appliance such as a light, radio, television, etc. within 1.5m of a spa pool unless such appliances are installed and built-in by the manufacturer.

5. ELECTRICAL SUPPLY:

The electrical supply for this product must include a suitably rated switch & RCD to open all ungrounded supply conductors to comply with the national electrical standards. This disconnect must be readily accessible and visible to the spa pool occupant but installed at least 1.5m from the spa pool's water.

6. WARNING:

To reduce the risk of injury:

- a) Water temperature between 38°C and 42°C is considered safe for a healthy adult. Lower water temperatures are recommended for young children and when the spa pool use exceeds 10 minutes.
- b) Since excessive water temperatures have a high potential for causing fetal damage during early months of pregnancy, pregnant women should limit spa pool use and water temperatures to no more than 38°C.
- c) Do not use alcohol, drugs, or medication before or during spa pool usage.
- d) Persons with a history of heart disease, low or high blood pressure, circulatory system problems, or diabetes should consult a physician before using a spa pool.
- e) Persons using medication should consult a physician before using the spa pool as some medication may induce drowsiness, while other medication may affect heart rate, blood pressure, and circulation.

7. WARNING:

To prevent electrocution, do not modify or connect any additional auxiliary components (for example cable, speakers, headphones, additional audio/video components, etc) to the system.

8. CAUTION:

Risk of electrical shock. Do not service the spa pool controller yourself as opening or modifying the controller may expose you to dangerous voltage or other risk of injury. Refer all servicing to qualified service personnel unless advised otherwise by the retailer.



9. CAUTION:

Risk of electrical shock. If the power supply connections or power supply cord(s) are damaged, if water is entering the audio / video compartment or any electrical equipment compartment area, if the protective shields or barriers are showing signs of deterioration, or if there are signs of other potential damage to the unit: turn off the unit and refer the servicing to Alpine Spas.

- 10.** The spa pool should be subject to periodic routine maintenance and care according to the 'Spa Pool Care & Maintenance' and 'Service Information' sections of this manual.
- 11.** Installation of the spa pool for anything other than a residential dwelling may result in voiding the manufacturer's warranty. Please contact the dealer to confirm.
- 12.** Do not bring any object into the spa pool that could damage the spa pool shell.
- 13.** Never insert any object into any opening.

14. WARNING:

Do not sit on the spa pool cover or place objects on it.

- 15.** Remove any water or debris that may collect on the spa pool cover.

16. WARNING:

Do not use the spa pool immediately after strenuous exercise.

- 17.** If you feel pain or dizziness at any time while using the spa pool, discontinue use and contact a physician.

18. WARNING:

Observe reasonable time limits when using the spa pool. Long exposures at high temperatures can cause high body temperatures. Symptoms may include dizziness, nausea, fainting, drowsiness, and reduced awareness. These effects could possibly result in drowning or hypothermia.

19. WARNING:

The spa pool's jets produce a stream of water with relatively high pressure. Prolonged exposure to localised areas of the body may cause bruises to the skin.

20. WARNING:

To avoid risk of drowning, the spa pool cover should be in place and properly latched when spa pool is not in use.

21. IMPORTANT:

Read and understand the warnings on the spa pool cover.



FAILING TO READ AND UNDERSTAND THE BELOW INSTRUCTIONS MAY VOID YOUR SPA POOL WARRANTY.

DO NOT leave the spa pool empty and exposed to direct sunlight without its cover - doing so may damage the acrylic.

DO NOT power the spa pool without first filling with water.

DO NOT allow the water level to fall below the filter/skimmer box. The water level should be kept in line with the perimeter LEDs or at least 50mm above the bottom of the skimmer box at all times.

DO NOT allow any persons to place their head under the water.

DO NOT roll or slide the spa pool on its side.

DO NOT use any chemicals or water balancing products in the spa pool, other than those sold or provided by Alpine Spas or Spa Supplies.

DO ensure a water maintenance regime is used and followed regularly. Failing to balance water or sanitise correctly can damage spa pool components and void warranty. A guide is provided which should be followed carefully.

DO ensure the spa pool cover is placed on the spa pool and locked when not in use.

DO perform a regular spa pool cleaning schedule as instructed by this manual.

DO drain and refill your spa pool at least every 3-4 months or more frequently if required.

DO ensure at least 4 hours of filtration is performed by the spa pool each day (this is set as a default).

DO ensure the spa pool cover is opened every few days for a few minutes (if unused) to avoid build up of gas under the cover.



Placing/Installing the Spa Pool

Choosing the Best Position

When choosing where to position your spa pool, the first thing you should consider is what is going beneath it. Your spa pool is very heavy, weighing anything between 1000kg and 3000kg when filled. It is therefore very important you choose an adequate foundation that is strong and level to ensure there is no shifting or strain on the spa pool shell or framing.

The base we recommend you use is at least a 100mm concrete pad or a reinforced deck. If you choose a deck as a base, please check that it complies with all AUS/NZ building standards and that its max load rating will adequately withstand your spa pool's weight, plus the total bather load weight.

Check Drainage

You need to be sure the area in which the spa pool is placed has enough drainage capacity to handle the entire water content of the spa pool. In the event of spillage, areas around the spa pool may become wet; therefore, all flooring, furniture, walls and adjacent structures should be moisture-resistant.

Check Service Access

It is important to consider the access to the cabinet surrounding the spa pool. In the unlikely event of a leak or issue with components, a service agent may require access to a particular cabinet. We advise leaving a 600mm perimeter of space around the entire spa pool, otherwise the spa pool may need to be moved by the customer into a position suitable for a technician at the time of service.

Access to all cabinets is the responsibility of the owner.

Detailed Installation Guide

For more detailed information and tips on positioning and installing, we highly recommend you read through our 'Pre-Delivery Guide'. The guide was emailed to you upon/after purchase. A copy can be downloaded from the link at the bottom of this page.



FAILURE TO FOLLOW THE INSTRUCTIONS IN THE PRE-DELIVERY GUIDE MAY RESULT IN VOIDING YOUR SPA POOL WARRANTY.



Download the 'Pre-Delivery Guide' from our support page:
www.alpinespas.co.nz/support or www.alpinespas.com.au/support

4 | INSTALLATION INSTRUCTIONS

SPA POOL CONTENTS

Separate Items:



Spa Pool



Spa Pool
Safety Cover



Water Care
Startup Kit
(optional extra)
[Products differ in AU]



Cover Lifter
(Optional extra)

Items Packaged Inside the Spa Pool:



Spa Pool
2-Tier Steps
(Select Models)



1-2 Filter/s
(Select Models)



1 Spare
Vertical Slat
(Select Models)



iPack
(Accessories
& Manuals Bag)

Items Packaged Inside the iPack:



Drain Valve to
Garden Hose
Attachment



Cable Exit
Grommet



Manuals &
Warranty Card



Cover Keys &
Screws



iPack Bag
Carry Straps

ASSEMBLING THE ACCESSORIES

Spa Pool Cover

The cover requires minimal installation other than unpacking and placing on top of the spa pool. There are 8 safety locks hanging off the sides of the cover which need to be screwed into the spa pool cabinet by the customer. Screws and cover keys should be included in the iPack.

Spa Pool Steps (Select Models)

Assembling the two-tier steps is self-explanatory. Simply click together, no tools required. Our steps measure 600 x 665mm (W x L).

Note: The Yukon and Quebec 3-tier steps are wooden & pre-assembled.



Spa Pool Cover Lifter (Optional Extra)

The cover lifter needs to be assembled onto the spa pool, please follow the instructions carefully. Some brackets may need to be secured onto the spa pool cabinet. Certain setups may have restrictions - see our 'Cover Lifter Installation Guide' for confirmation.



Download the 'Cover Lifter Installation Guide' from our support page: www.alpinespas.co.nz/support or www.alpinespas.com.au/support

PRE-FILL PROCEDURE

STOP!! BEFORE FILLING, START HERE!



FAILING TO FOLLOW THIS PROCEDURE MAY RESULT IN ISSUES STARTING UP THE SPA POOL OR VOIDING WARRANTY.

Steps to Prepare for Filling:



1

Check the silver plaque on the side of spa pool cabinet (or see your invoice) to find your spa pool model's name, then read pages 38 - 69 for more specific info about your spa pool.



2

As the spa pool has been water tested during manufacturing, excess water residue may have splashed out from within the pipes during transport and may require a quick wipe.



3

Open all of the spa pool jets by turning them anti-clockwise. This will allow water to flow through all pipes when filling and help avoid air-locks.



4

Check the external drain valve is in the 'flow-locked' position (retracted) with the inner twist cap screwed in tight.

FILL LEVEL WARNING



FAILURE TO KEEP SPA POOL FILLED TO MINIMUM REQUIRED LEVEL (AS SEEN BELOW) WILL RESULT IN DAMAGE TO COMPONENTS. MONITOR WATER LEVEL AND REFILL AFTER USE. SWITCH OFF SPA POOL IMMEDIATELY IF WATER LEVEL DROPS BELOW FILTER BOX.



Minimum water level for grate style skimmer.



Minimum water level for floating weir skimmer.



Minimum water level for open-top style skimmer.

FILLING THE SPA POOL - OPEN-TOP SKIMMER

LUCANIA, QUEBEC, MATTERHORN, MUNRO, VANCOUVER, VERMONT AND GRAND CANYON SPA POOLS.



Place your hose inside the open-top skimmer box and begin filling.



Fill until the water line meets the minimum water level required as indicated in previous 'FILL LEVEL WARNING' diagram. Usually an inch below the headrests.



FILLING THE SPA POOL - FLOATING WEIR SKIMMER

ASPEN, FUJI, NEPAL, NEVADA, NORDIC, BELMONT, OREGON, DUO, OHIO AND YUKON SPA POOLS.



1
Unthread the plastic screw on top of the cup holder that is resting on the skimmer box lid.



2
Remove the cup holder that is resting on the skimmer box lid.



3
Place your hose through a gap in the skimmer box lid to secure it and begin filling.



4
Fill until the water line meets the minimum water level required as indicated in previous 'FILL LEVEL WARNING' diagram. Usually an inch below the headrests.





ELECTRICAL WIRING / POWERING UP



ANY ELECTRICAL WIRING WORK MUST BE PERFORMED BY A LICENSED ELECTRICIAN.

The model name is imprinted on a silver plaque, usually located along the bottom edge of the spa pool cabinet. Check around the whole perimeter of the spa pool to locate.



Silver Plaque

Electrical Information Per Model

MODEL	AMP	CABLE/PLUG	TECH INFO / WIRING
DUO	10A*	10A CABLE & PLUG INCLUDED	See Page 36
OHIO	10A*	10A CABLE & PLUG INCLUDED	See Page 38
FUJI	15A*	15A CABLE & PLUG INCLUDED	See Page 38
BELMONT	15A*	15A CABLE & PLUG INCLUDED	See Page 40
OREGON	15A*	15A CABLE & PLUG INCLUDED	See Page 42
NEPAL	15A*	15A CABLE & PLUG INCLUDED	See Page 44
NORDIC	15A*	15A CABLE & PLUG INCLUDED	See Page 46
ASPEN	15A*	15A CABLE & PLUG INCLUDED	See Page 48
YUKON	15A*	15A CABLE & PLUG INCLUDED	See Page 50
VERMONT	15A*	15A CABLE & PLUG INCLUDED	See Page 52
NEVADA	15A*	15A CABLE & PLUG INCLUDED	See Page 54
MATTERHORN	15A*	15A CABLE & PLUG INCLUDED	See Page 56
LUCANIA	15A*	15A CABLE & PLUG INCLUDED	See Page 58
QUEBEC	15A*	15A CABLE & PLUG INCLUDED	See Page 60
VANCOUVER	25A	HARDWIRE REQUIRED	See Page 64
MUNRO	25A	HARDWIRE REQUIRED	See Page 66
GRAND CANYON	32A**	HARDWIRE REQUIRED	See Page 68

*10A-15A is the pre-set default for these spa pool models which means the system will automatically load-shed (disable) the heater when the pumps (jets) are turned on. These 10A-15A models can be wired with a 25A feed to disable load shed. See following page for details.

**32A is the pre-set default for these spa pool models which means the system will automatically load-shed (disable) the heater when the pumps (jets) are turned on. These 32A models can be wired with a 45A feed to disable load shed. See following page for details.

4 | INSTALLATION INSTRUCTIONS

Setting Up a 10A Model:



A 10A spa pool requires a 10A electrical socket protected by a residual current device (RCD) for the default setup.

By default these spa pools will NOT draw more than 10A at any one time. This is the default factory setup which load-sheds (disables) the heater when the pumps (jets) are turned on*. A 10A socket is the most common socket you will find around your house and in outdoor areas.

It is strongly advised to have an electrician check over your desired power supply (10A plug) to make sure there is enough electrical supply to power the Spa Pool and anything else on the same circuit. This will help prevent overloading the power supply which can cause damage later down the track.

A 10amp cable with 3-pin plug has been pre-wired to the spa pool's system controller and can be found coiled up inside the cabinet. To find out which cabinet to remove to access the cable, see your spa pool's corresponding tech info/wiring page (using the table on the previous page).



Cable grommet after installation

The cable can be exited through the cabinet wall (a cable grommet is supplied in the iPack). A drill with a 60mm hole-saw attachment will provide the right size for the grommet.

Setting Up a 15A Model:



A 15A spa pool requires a 15A electrical socket protected by a residual current device (RCD) for the default setup.

By default these spa pools will NOT draw more than 15A at any one time. This is the default factory setup which load-sheds (disables) the heater when the pumps (jets) are turned on*.

A 15amp cable with 3-pin plug has been pre-wired to the spa pool's system controller and can be found coiled up inside the cabinet. To find out which cabinet to remove to access the cable, see your spa pool's corresponding tech info/wiring page (using the table on the previous page).

The cable can be exited through the cabinet wall (a cable grommet is supplied in the iPack). A drill with a 60mm hole-saw attachment will provide the right size for the grommet.



Cable grommet after installation

***NOTE:** *The default 10/15A setup is the most economical way to run the spa pool. If you wish to avoid load-shed, a 25A supply would need to be hardwired to your switchboard. A guide for your electrician to achieve this can be downloaded from our support page.*



Information to disable load shed (changing 10/15A to 25A or 32A to 45A) can be downloaded from our support page:
www.alpinespas.co.nz/support or www.alpinespas.com.au/support



Setting Up a 25A, 32A or 45A Model



A 25A, 32A or 45A spa pool requires a dedicated feed from your circuit board and appropriate Residual Current Device & Isolation switch.

An electrician is required to setup and connect the appropriate wiring and accessories. To locate the system controller, see your spa pool's corresponding tech info/wiring page (using the table on the previous page).

The cable should be fed through the cabinet wall. A cable grommet is supplied in the iPack should you wish to use this and a drill with a 60mm hole-saw attachment will provide the right size for the grommet (see above image). Alternatively, a tighter fit can be achieved without the grommet by just using a drill bit the same size as the flex diameter and drilling through the cabinet wall.

INSTALLING THE FILTER CARTRIDGES - OPEN-TOP SKIMMER

LUCANIA, QUEBEC, MATTERHORN, MUNRO, SIERRA, VANCOUVER, VERMONT AND GRAND CANYON SPA POOLS.

Filter(s) are found inside the spa pool but not pre-installed.



1

Locate the open-top skimmer that is below the waterfall.



2

Inside you will see holes for your filters to screw into (circled above in red).



3

Unwrap the plastic from your filters and place them inside the open-top skimmer, aiming for holes.



4

Thread in the two filters gently (clock-wise).



5

Once threaded in, the filters should sit inside the skimmer box in an upright position.



AVOID DAMAGE TO SPA POOL & VOIDING WARRANTY - ONLY USE FILTER CARTRIDGES PURCHASED FROM ALPINE SPAS OR SPA SUPPLIES.

5 | STARTUP & REFILL PROCEDURE

INSTALLING THE FILTER CARTRIDGES - FLOATING WEIR SKIMMER

ASPEN, FUJI, NEPAL, NEVADA, NORDIC, BELMONT, OREGON, DUO, OHIO AND YUKON SPA POOLS.

Filter(s) are found inside the spa pool but are not pre-installed.



1
Unthread the plastic screw on top of the cup holder that is resting on the skimmer box lid.



2
Remove the cup holder that is resting on the skimmer box lid.



3
Grab the top lid with two hands, apply light downwards pressure and twist anti-clockwise to detach (can be quite stiff).



4
Lift out the basket grill and place aside.



5
Inside the skimmer box, see the circular holding piece that the filter cartridge will sit over.



6
Unwrap the plastic from your filter and insert the filter into the circular holding piece so it sits tight.



7
Insert the basket grill into the top of the filter, lining up the circular hole. Press the basket down gently to ensure a tight fit.



8
Replace the top lid by gently putting downwards pressure while turning clockwise, until it snaps back into place.



9
Put the cup holder on top again and secure it in place with the plastic screw.



AVOID DAMAGE TO SPA POOL & VOIDING WARRANTY - ONLY USE FILTER CARTRIDGES PURCHASED FROM ALPINE SPAS OR SPA SUPPLIES.



SWITCHING ON & HEATING UP

Automatic Startup Procedure

Upon activating power, the spa pool's topside control panel should light up and the screen will display a series of specific sequences and numbers. If the screen is blank when you power on, switch off/on again.

Priming

The spa pool will enter a 'priming mode' whenever it is first initiated or restarted. This is startup function which will run the circulation pump to clear any air in the plumbing for 20 seconds at a time.

The topside control panel will display "PRIMING" or similar to indicate the priming mode state.

Check that the circulation pump has engaged by visually sighting moving/rippling water inside spa pool. Water may flow from the waterfall (if open and equipped).

Note : The waterfall will only flow when the circulation pump is running (heating or filtering) and when the dial is open. See your Spa pools model overview to help locate the dial.

If the priming function fails, an error message (likely to be ER3-Water Prime) will display on the topside control panel - check the troubleshooting guide at the back of this manual for assistance.

HEAT-UP PROCESS

Automatic Heating

After priming has finished, the spa pool is automatically configured to begin heating to 38°C. The circulation pump will engage and the spa pool will begin filtering and heating up automatically.

Note: A default snooze timer is in place which disables functions (including heating) between 22:00 – 07:00. This will slow initial heat up time if not temporarily disabled. You must set the time (clock) on the topside control panel and then disable the snooze timer to allow for a fast first time heat-up. See pages 28-29.

Installing the Cover

Place your spa pool cover on top of the spa pool and lock it down by installing the clips with the screws. Screws and keys can be found in the iPack.

Heat Up Time

Depending on environment, it can take up to 12-18 hours to heat the spa pool to the default 38°C (or longer if snooze timer was not temporarily disabled).



BALANCING & SANITISING THE WATER



FAILING TO BALANCE AND SANITISE YOUR SPA POOL CORRECTLY MAY RESULT IN CORROSION OR DAMAGE TO COMPONENTS, WHICH IS NOT COVERED UNDER WARRANTY.

Just like a car, your spa pool needs care and general maintenance to keep it looking good and running smoothly. An integral part of this maintenance is managing the water quality.

To ensure your spa pool is ready to be used at all times, the water needs to be sanitised and balanced to keep it clean and fresh.

You may have received a Water Care Startup Kit with your spa pool (please purchase one if you have not). Follow the 'Spa Pool Water Care Handbook' found in your iPack or download a copy from our support page link at the bottom of this page.

Follow the water care startup procedure found in the Spa Pool Water Care Handbook to setup the water for use.

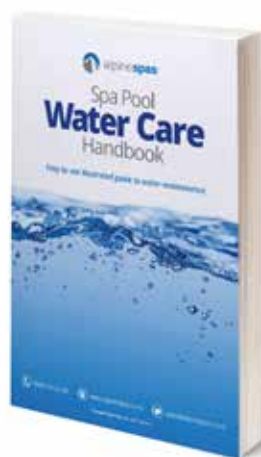

Only use products supplied by Alpine Spas or Spa Supplies (including filter cartridges) in your spa pool. Use of unapproved products may result in your warranty becoming void, please contact us if in doubt.

Your first steps in treating the spa pool water will require the use of the topside control panel. See the quick reference guides on the following pages.

Spa Supplies is an online store with warehouses in both New Zealand and Australia where customers can exclusively purchase Alpine-approved products. Alpine Spas customers can also purchase chemicals and filters at their local Alpine showroom.



Download our 'Spa Pool Water Care Handbook' from our support page: www.alpinespas.co.nz/support or www.alpinespas.com.au/support





TOPSIDE CONTROL PANEL QUICK GUIDES

OVERVIEW

The 'topside control panel' is the main control for your spa pool where you can set temperature and turn on pumps and lights. It's also where you will apply settings to control how the spa pool operates.

The following pages cover the different topside control panels associated with your particular spa pool model.

These quick guides provide an overview of the buttons and the actions they perform however the panels are capable of multiple functions not explained in the diagram.

A full copy of each topside control panel user manual can be downloaded from our support page.

Note: If your topside control panel does not light up when powering on, switch the spa pool off and on again.



Download full topside control panel user manuals from our support page: www.alpinespas.co.nz/support or www.alpinespas.com.au/support

SPANET SV-MINI 1
(DUO, OHIO OREGON & BELMONT)

HEAT RANGE
10 - 41.0°C

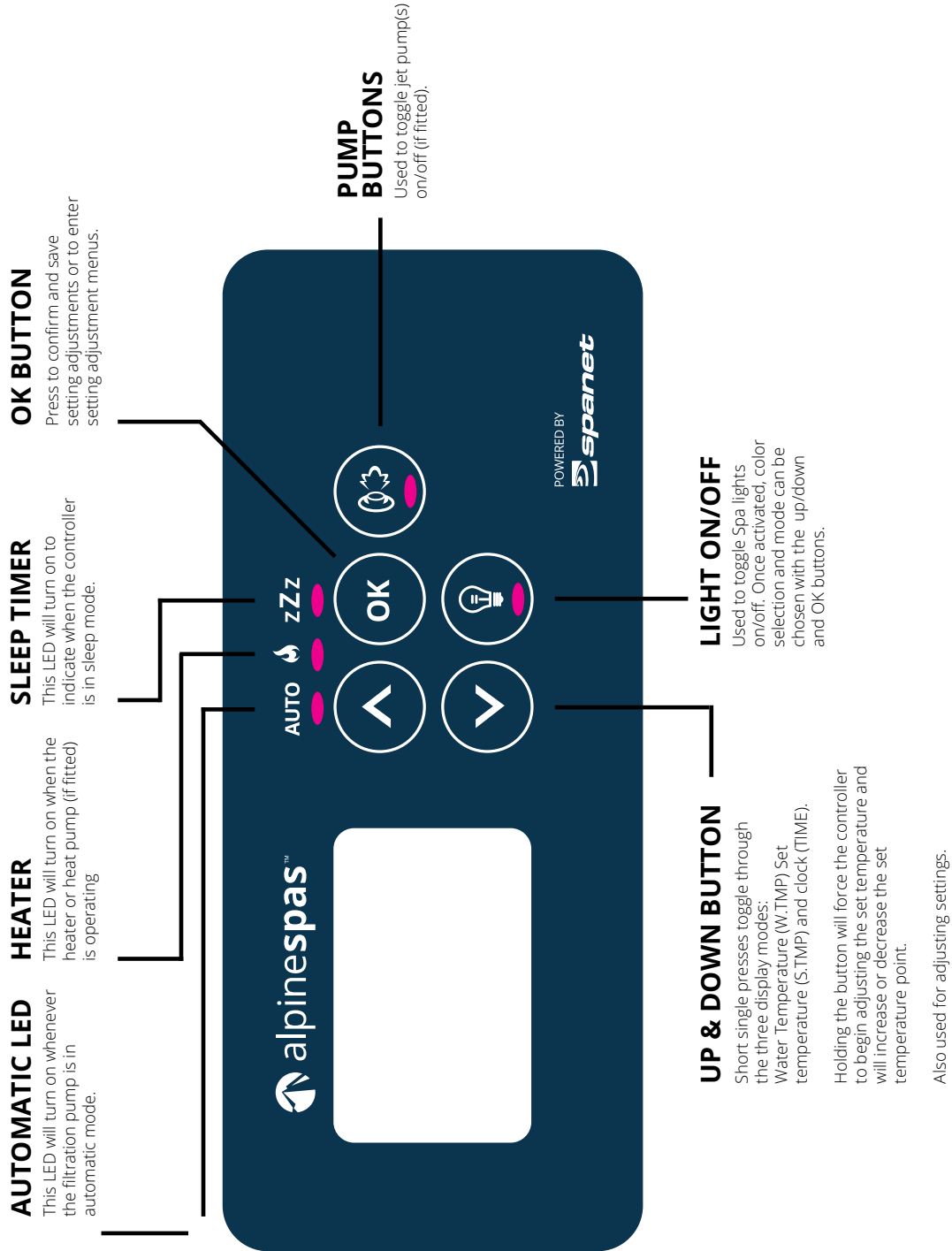

Spa pools with the SpaNET SV Mini 1 control system are limited to some features in this manual and some operations may differ. You can enhance your user experience by purchasing a SpaNET WIFI module to access certain features. Speak with your friendly sales consultant for more information.



SPANET SV-SMART

(FUJI, NEPAL, NORDIC, YUKON, ASPEN, LUCANIA & QUEBEC SPA POOLS)

HEAT RANGE

10 - 41.0°C

SANITISE BUTTON

Press once to activate a 20min sanitisation and clean up cycle to refresh water quality after spa use. A second press will cancel the cycle if already running.

WATER TEMP/ TIME

A shortcut key designed to quickly toggle between actual water temp and time display modes.

OK BUTTON

Press to confirm and save setting adjustments or to enter setting adjustment menus.

UP & DOWN BUTTON

Short single presses toggle through the three display modes: Water Temperature (W.TMP) Set temperature (S.TMP) and clock (TIME).

Holding the button will force the controller to begin adjusting the set temperature and will increase or decrease the set temperature point.

Also used for adjusting settings.

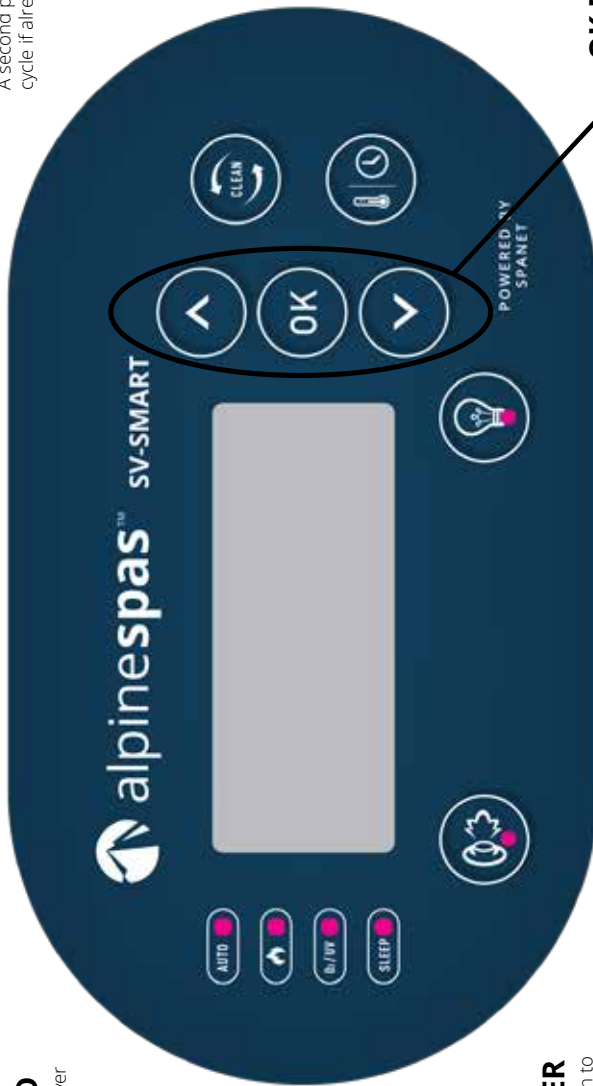

AUTOMATIC LED

This LED will turn on whenever the filtration pump is in automatic mode.

SLEEP TIMER

This LED will turn on to indicate when the controller is in sleep mode.

O₃/UV

This LED will turn on to indicate that the Ozone or UV purifiers are operating.

HEATER

This LED will turn on when the heater or heat pump (if fitted) is operating

LIGHT ON/OFF

Used to toggle Spa lights on/off. Once activated, color selection and mode can be chosen with the up/down and OK buttons.

PUMP BUTTONS

Used to toggle jet pump(s) on/off (if fitted).

SPANET SV-SMART
(VANCOUVER & MUNRO SPA POOLS)

HEAT RANGE
10 - 41.0°C

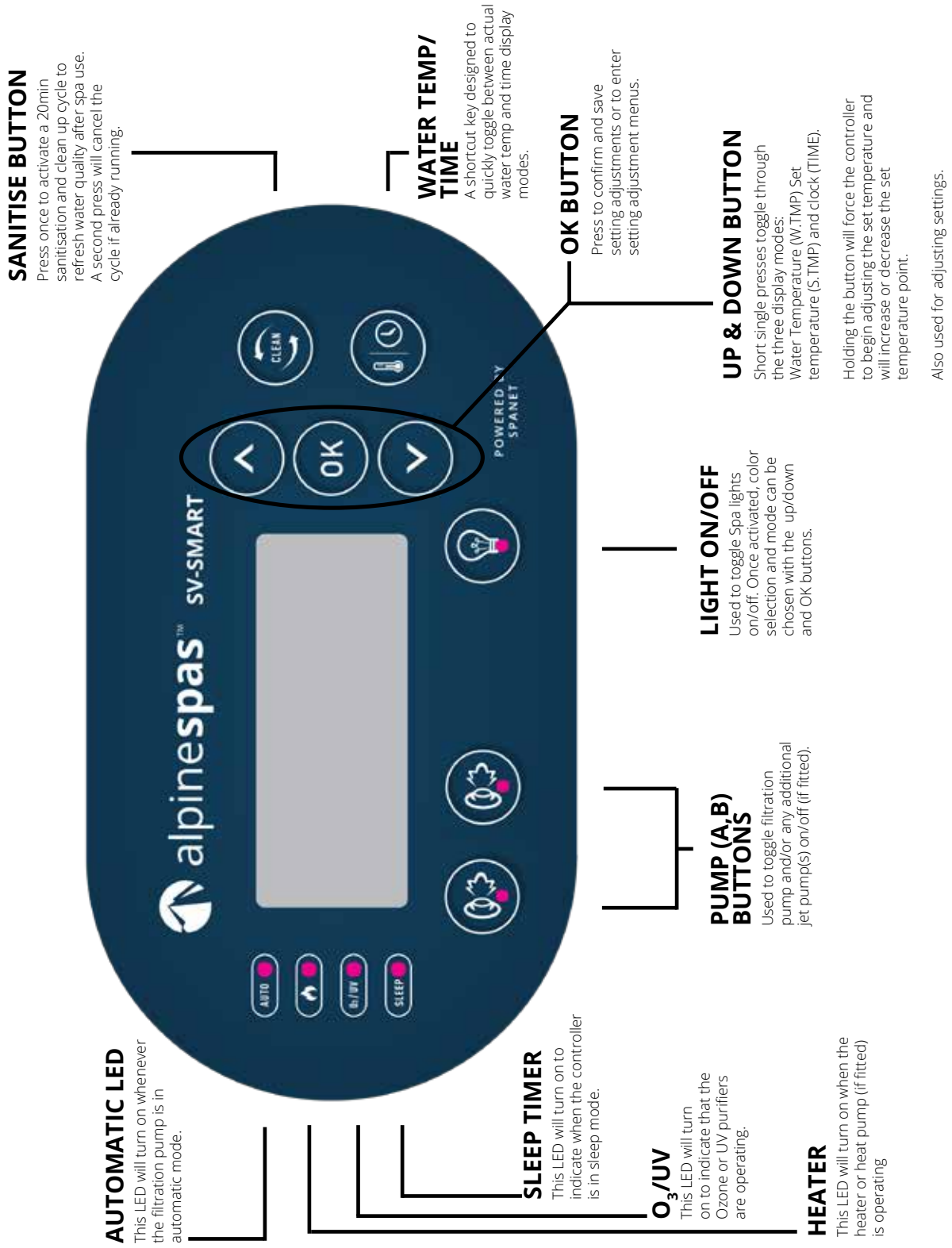



SPANET SMARTTOUCH

(MATTERHORN, NEVADA, VERMONT, QUEBEC & GRAND CANYON SPA POOLS)

HEAT RANGE

10 - 41.0°C

1. LIGHT SENSOR
The SmartTouch is equipped with a light sensor to automatically adjust the brightness of the LCD.

2. WATER TEMP
This displays the current water temperature of your spa pools water. Filtration is required for the sensor to show an accurate reading.

3. TIME, DAY & DATE
Displays the current time and date. Be sure to set this correctly on start-up.

4. PUMPS (A, B, C, D)
Press to toggle equipped pumps on & off (some models may only have two pumps).

5. AIR BLOWER
Non-applicable

6. LIGHT BUTTON
The light button is used to toggle the spa light(s) ON / OFF and to access the light mode adjustments.

7. CLEAN/SANITISE CYCLE
Press once to activate a 20 minute sanitisation & clean up cycle to refresh water quality after spa use. A second press will cancel the cycle if already running.

8. INVERT/FLIP SCREEN
The orientation of the touch pad display can be inverted (flipped 180o) for easier operation in and out of the spa pool.

9. INCREASE SET TEMP
Press this button to increase the set temperature.

10. SET TEMP
This displays your desired set temperature of your spa. Default is 38°C and can be adjusted using the increase (9) and decrease buttons (11).

11. DECREASE SET TEMP
Press this button to decrease the set temperature.

12. SETTINGS
The SmartTouch features a settings menu which allows customisation of adjustable software settings.

13. CURRENT ACTIVITY
This will display the current activity of the spa pools operations, eg Heating, Filtering, Mixing, Sanitise Cycle ...

14. STATUS INDICATORS
AUTO will turn on whenever the filtration pump is in automatic mode.
HEAT will turn on when the heater or heat pump (if fitted) is operating.
O3/UV will turn on to indicate that the Ozone or UV purifiers are operating.
FILT will turn on when the spa is in a filtration cycle
SLEEP will turn on to indicate when the controller is in sleep mode.

SPA POOL OPERATION

Post Heat-up

Once the default 38°C is reached the circulation pump will stop operating and will only re-engage if the spa pool loses temperature, a filter cycle has begun or the system is polling automatically to check temperature.

Understanding the Display (Topside Control Panel)

When the spa pool is first powered and priming has completed, the default display will show the current water temperature - this is referred to as W.TMP (water temp). You can cycle between the below three display modes by using the 'UP' or 'DOWN' buttons:

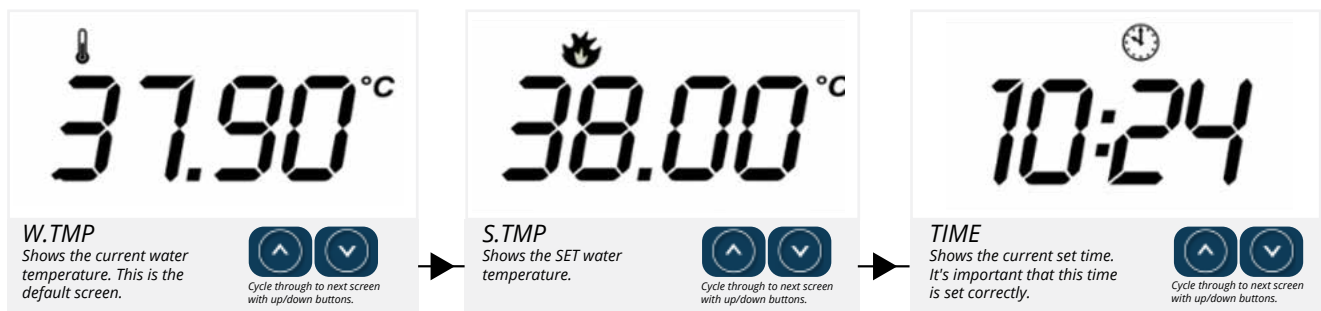

It's recommended to leave the display on W.TMP to see a clear difference between your set temperature and your current water temperature.

Changing the Temperature

Press and hold the 'UP' or 'DOWN' buttons to adjust the set temperature in the direction indicated on the button in increments of 0.2°C. When the display stops flashing, the spa pool will begin heating to the new set temperature (the spa pool cannot cool the water). The spa pool is already pre-set to 38°C.





Testing the Components (Jet Pumps)

Turn each individual jet piece inside the spa pool clockwise to open the flow. Then test the jet pump(s) via the topside control panel by pressing:

The 'PUMP' button/s will activate the jet pump/s and high pressured water will flow from the jet pieces. Turn the diversion valves to switch pressure between seats.



Setting the Time & Date

Be sure to set the correct date and time on the topside control panel. Vital functions such as filtration, sanitisation cycles and power saving settings are dependent on this being accurate.

Navigate to the TIME display by following the instructions on the previous page ('Understanding the Display') then follow these steps to set the time:



Spa Pool Behavior - Running Modes

Excluding models with a SV-MINI-1/2 Control panel (Duo, Belmont & Oregon) unless a SpaNET wifi module has been installed.

Your spa pool is pre-set to 'NORM' (normal) running mode by default which is the standard operating mode and it's recommend to leave this unchanged as it is the most economical mode for regular use. Normal mode means that the spa pool will always aim to keep the water temperature at the users set temperature (default 38°C) so it is ready to use whenever you are.

Other modes are available to use, which may be useful at different times of the year or if you cannot use the spa pool for a set period of time:

Name	Mode	Function
NORM	Normal	Normal operation for demand heating and filtration
AWAY	Away	Demand heating is DISABLED. Filtration is fixed at 1 hour per day (the keypad will scroll "AWAY MODE" every 60 secs)
WEEK	Week	Monday to Thursday: Demand heating is DISABLED and filtration fixed at 1 hour per day. Friday to Sunday: Normal Operation

Changing the Running Mode



Filter Cycles

A filter cycle is a period in which the circulation pump is run for a user programmed length of time. This allows for a dedicated period of water sanitising and clean up. Heavier spa pool usage may require longer filter cycle times. At the start of each filter cycle, the main jet pump may run briefly to purge the plumbing.

Filter cycle operation consists of two separate programmable parameters:

- Duration of filtration per day [FILT] (hours per day, e.g. 4 hours total per day)
- Filter cycle blocks [F.CYC] (time between start of each filter cycle, e.g. 3 hours)

The default settings are: 4 hours of filtration per day over 3-hourly filter blocks (e.g. every 3 hours, an hour long filter cycle will engage).

Models with a SV-MINI-1/2 Control panels (Duo, Belmont & Oregon) do not have adjustable Filter Cycle Blocks (F.CYC) unless a SpaNET wifi module has been installed.
Default 3 hours

Setting Filter Cycle Hours of Filtration [FILT]

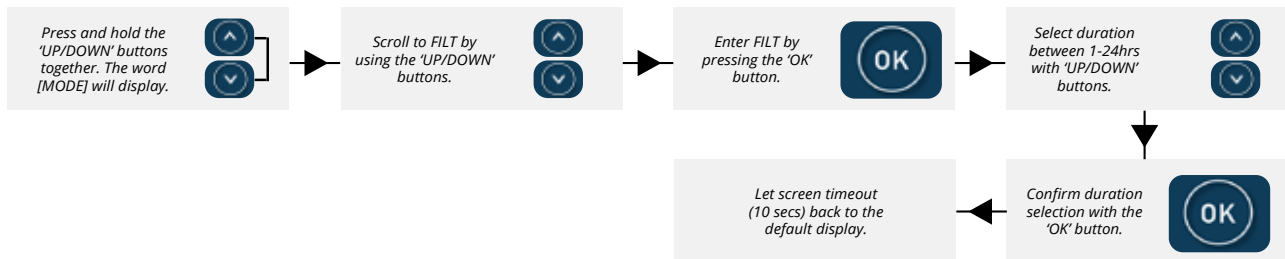

Setting Filter Cycle Blocks [F.CYC]:

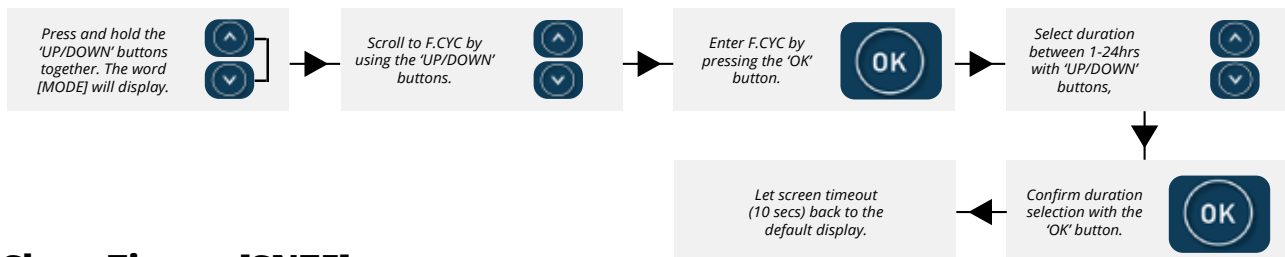

Sleep Timers [SNZE]

Sleep timers are a very handy feature which enables the user to stop all spa pool activity during certain times of day or night. While the controller is in sleep mode NO automatic heating or filtration maintenance will occur, however the spa pool can still be operated by manual use without the need to adjust sleep time settings. The spa will go back to sleep 45 minutes after the last button press on the touch pad.

There are two individual sleep timers that can be set, each of which can operate on one or more specified weekdays. This enables the user to program different sleep times for different days (i.e. weekdays vs weekends), as well as customizing the settings on a particular day/time where the user may want the spa pool silenced.

Default Sleep Timer Settings: Sleep Timer 1 (Sat – Fri; Sleep period 22:00 – 07:00).



Disabling the Default Sleep Timer [SNZE]

Follow these steps if you wish to quickly disable the default sleep timer:

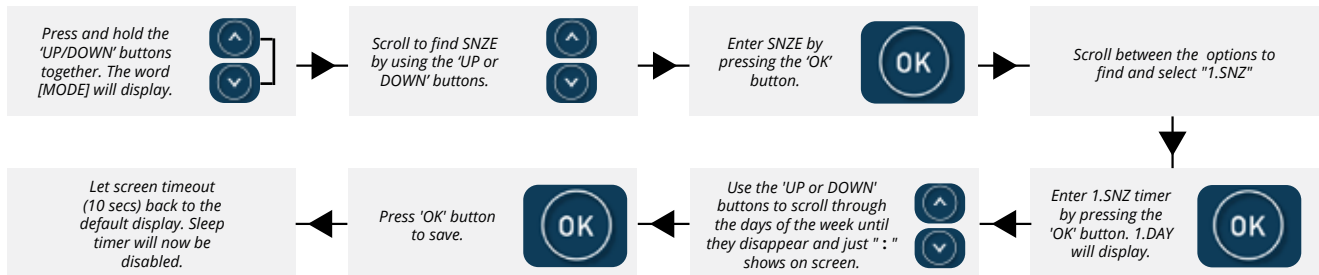

Setting & Adjusting Sleep Timers [SNZE]

Two individual sleep timers can be set, each of which can operate on one or more specified weekdays. These appear in the form of [1.SNZE] and [2.SNZE] in the settings. Each sleep time setting consists of a week day setting, start time and stop time (refer table below).

Models with a SV-MINI-1/2 Control panels (Duo, Belmont & Oregon) only have one sleep timer (1.SNZ).

Item	Description	Notes
#.DAY	Selected day of operation	Sat / Sun / Mon / Tue / Wed / Thu / Fri Sat-Sun / Mon-Fri / Sat-Fri / : Default = Sat-Fri (Note : = disabled)
#.BGN	Begin Time Sleep time period begins	Adjustable: 00:00 - 23:59 Default = 22:00 (10PM)
#.END	End Time Sleep time period ends	Adjustable: 00:00 - 23:59 Default = 07:00 (7AM)

The following instructions are an example of how to adjust one of the sleep timers:

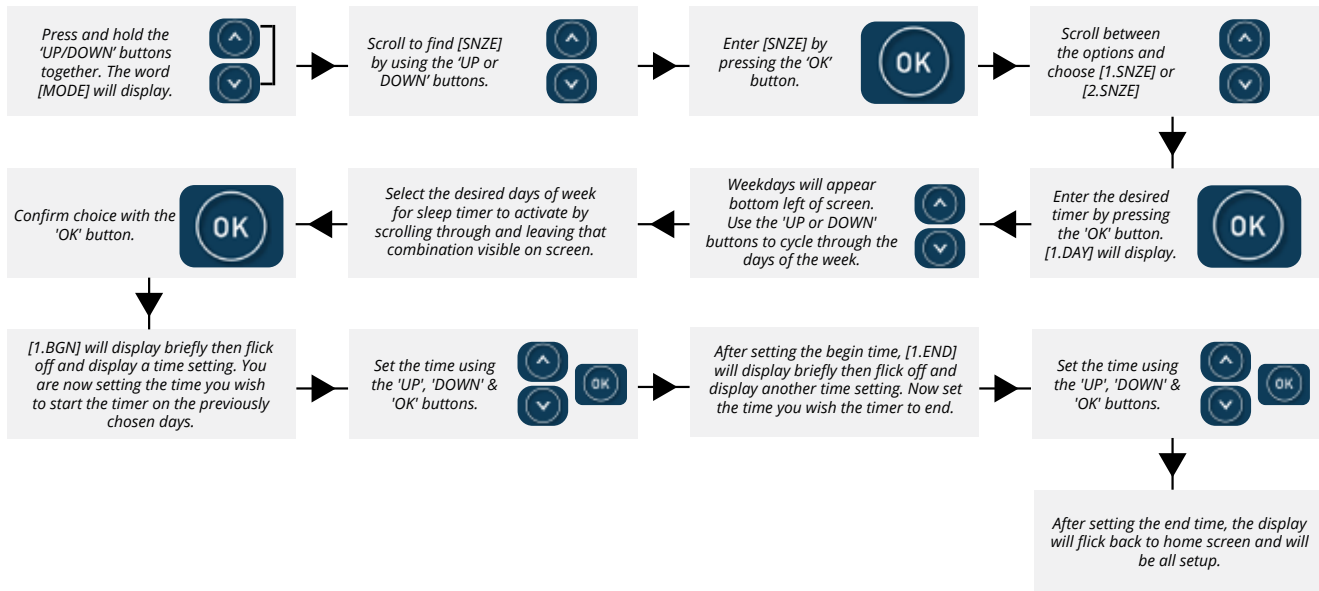

Power Save [P.SAV]

Excluding models with a SV-MINI-1/2 Control panel (Duo, Ohio, Belmont & Oregon) unless a SpaNET wifi module has been installed.

Power utilities in some regions offer household power meters that can track power usage during different times of the day. This allows the utilities to offer greatly reduced power pricing during off peak power times.

The Power Save (P.SAV) function allows the user to program in the peak power period so the spa control knows not to perform filtration and/or heating during those expensive hours. Instead the controller will take advantage of the competitively priced off peak hours, and run the filtration and/or heating during the off peak hours.

NOTE: If P.SAV function is to be used the spa user MUST consider any sleep timers [SNZE] and adjust them accordingly. Sleep timer settings will OVERRIDE any P.SAV settings. Running P.SAV function while sleep timer is set will likely result in cold water temperatures due to insufficient heat time available.

Setting & Adjusting Power Save [P.SAV]

The power save setting consists of a choice of mode, peak power period start time and peak power period end time (refer table below).

Item	Description	Notes
P.SAV	Power Save Mode Functions disabled during peak power periods	OFF = P.SAV disabled (default) LOW = Filtration disabled HIGH = Filtration & Heating disabled
BGN	Begin Time Peak power period begins	Adjustable: 00:00 - 23:59 Default = 14:00 (2PM)
END	End Time Peak power period ends	Adjustable: 00:00 - 23:59 Default = 20:00 (8PM)

Reminder that the hours you are programming into the system with the P.SAV feature is for when the heating and/or filtration will NOT occur.

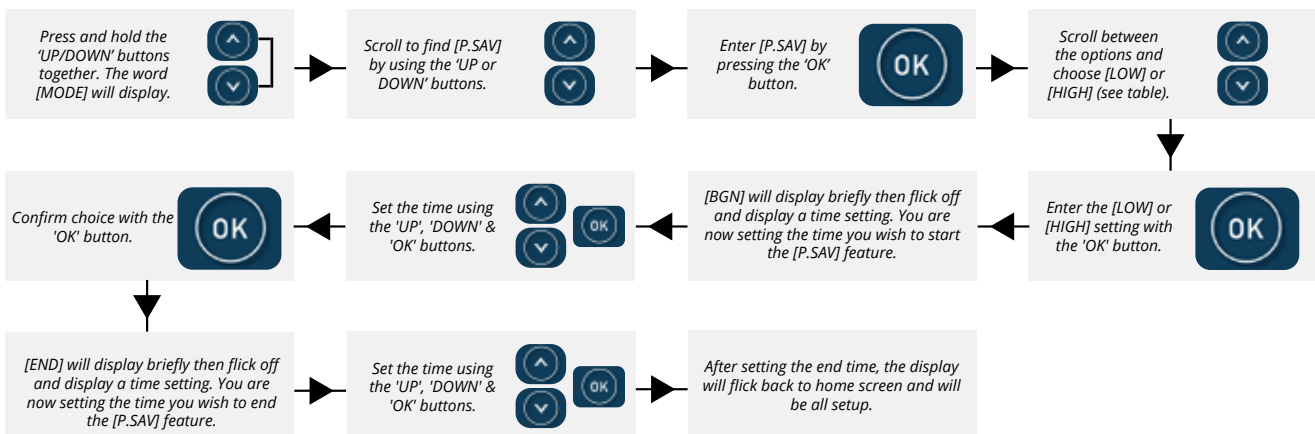



Sanitise/Clean-up Cycle

Excluding models with a SV-MINI-1/2 Control panel (Duo, Belmont & Oregon) unless a SpaNET wifi module has been installed.

The sanitise button activates a 20 minute sanitisation cycle that runs the filtration pump and ozone / U.V to filter the spa pool water to restore and refresh water quality. At the start and end of the cycle, the controller will sequentially (one at a time) run a variety of pumps for one minute each to purge the plumbing and clear any unfiltered water trapped in those lines.



Key-lock Function

The keypad buttons can be locked to prevent accidental key presses or to limit access to certain controller functions. This feature is particularly helpful when spa pool covers are used or where children are present.

There are two types of key-locks available:

Full Lock Mode - locks all buttons so all presses are ineffective until unlocked.
To activate full lock, press and hold together:



Partial Lock Mode - only 'PUMPS', 'LIGHT' and 'SANITISE' buttons allowed.
To activate partial lock, press and hold together:



NOTE: To unlock, repeat the sequence. Pumps are labeled A, B, C from left to right on the control panel. A spa model without a physical 'pump b' will still have a 'ghost button' where 'pump b' would be located and can still be pressed to activate the partial lock.

Automatic Daily Sanitise Cycle Run Time

The system will activate a 10 minute daily sanitisation cycle at 9am each day. Each pump is operated to purge pipe work whilst operating the filtration pump.



A full SpaNet control panel manual with advanced functions can be downloaded from our support page: www.alpinespas.co.nz/support or www.alpinespas.com.au/support

DUO SPA POOL OVERVIEW

Components:

Spa Pool Controller	SpaNet SV-MINI-1
Topside Control Panel	SpaNet SV-MINI-1
Heater Element	2KW
Pumps	Two-Speed Pump (2HP) (Circulation & Jet Massage)
Skimmer/Filter Type	Floating Weir
Sanitisers	Ozone
Electrical Info	10A/25A 230 - 240V AC 50hz IPX5
Cable	10amp Cable Pre-Connected

Cable & Wiring:

This 10amp spa pool includes a 4.5metre 10amp power cable that has been pre-connected and installed onto the system controller.



BELOW DIAGRAM IS FOR SINGLE PHASE 10A AND IS ONLY REQUIRED IF DISCONNECTING & RECONNECTING CABLE. DIP SWITCHES DO NOT NEED ALTERING.

DO NOT POWER THE SPA POOL BEFORE IT HAS BEEN FILLED

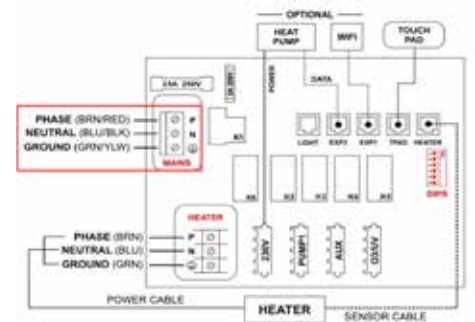
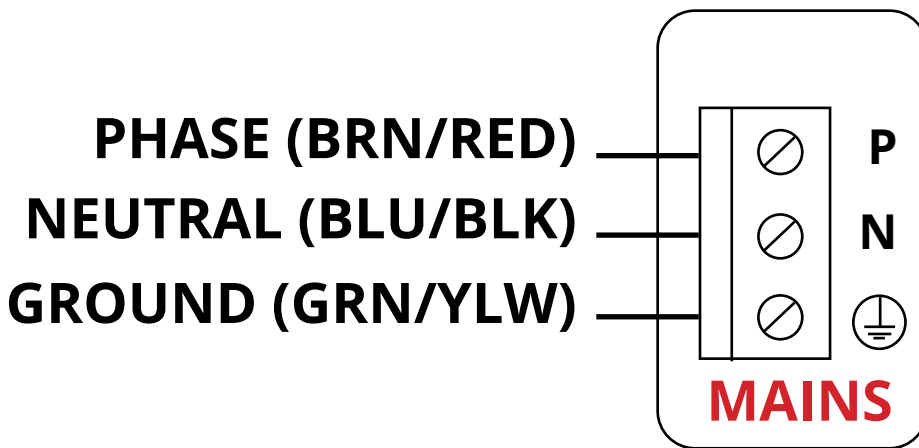

To setup for high amp (25A, no load shed*) see page 17 for information.

Locating the Controller & Cable

Remove the cabinet panels from the side of the spa pool that houses the system controller (see following page for exact location). Inside you will find the cable coiled up.





Identify labeled parts on pages 70 - 72



FRONT OF SPA

OHIO SPA POOL OVERVIEW

Components:

Spa Pool Controller	SpaNet SV-MINI-1
Topside Control Panel	SpaNet SV-MINI-1
Heater Element	2KW
Pumps	Two-Speed Pump (2HP) (Circulation & Jet Massage)
Skimmer/Filter Type	Floating Weir
Sanitisers	Ozone
Electrical Info	10A/25A 230 - 240V AC 50hz IPX5
Cable	10amp Cable Pre-Connected

Cable & Wiring:

This 10amp spa pool includes a 4.5metre 10amp power cable that has been pre-connected and installed onto the system controller.



BELOW DIAGRAM IS FOR SINGLE PHASE 10A AND IS ONLY REQUIRED IF DISCONNECTING & RECONNECTING CABLE. DIP SWITCHES DO NOT NEED ALTERING.

DO NOT POWER THE SPA POOL BEFORE IT HAS BEEN FILLED

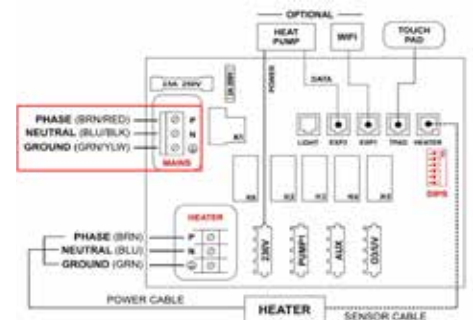
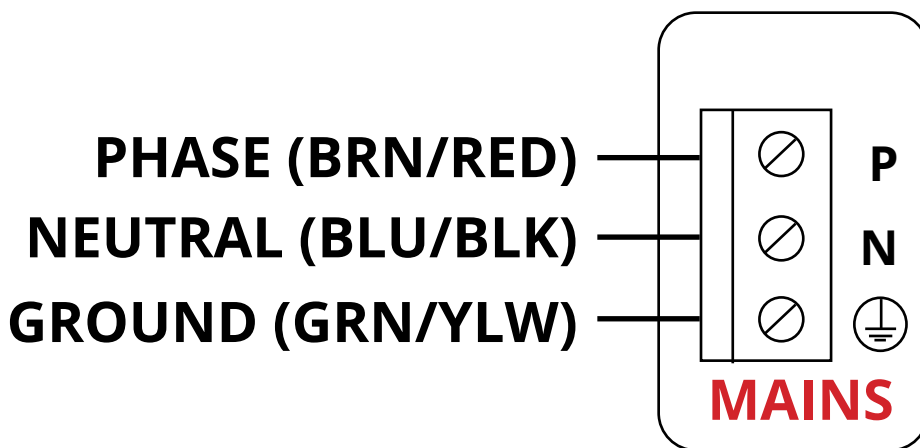

To setup for high amp (25A, no load shed*) see page 17 for information.

Locating the Controller & Cable

Remove the cabinet panels from the side of the spa pool that houses the system controller (see following page for exact location). Inside you will find the cable coiled up.





Identify labeled parts on pages 72 - 74

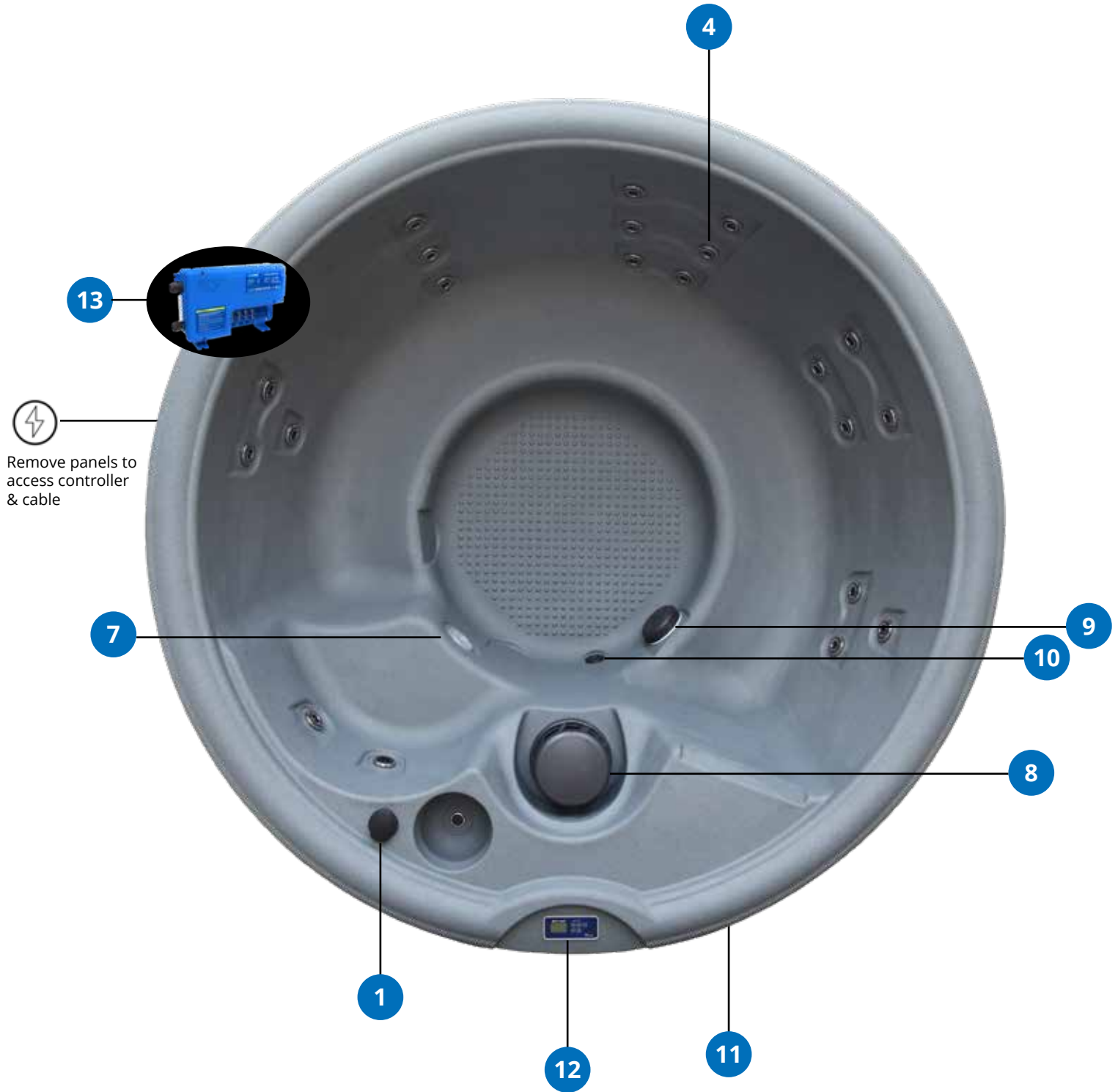

FRONT OF SPA

FUJI SPA POOL OVERVIEW

Components:

Spa Pool Controller	SpaNet SV-SMART
Topside Control Panel	SpaNet SV-SMART
Heater Element	3KW
Pumps	Two-Speed Pump (2HP) (Circulation & Jet Massage)
Skimmer/Filter Type	Floating Weir
Sanitisers	Ozone
Electrical Info	15A/25A 230 - 240V AC 50hz IPX5
Cable	15amp Cable Pre-Connected

Cable & Wiring:

This 15amp spa pool includes a 4.5metre 15amp power cable that has been pre-connected and installed onto the system controller.



BELOW DIAGRAM IS FOR SINGLE PHASE 15A AND IS ONLY REQUIRED IF DISCONNECTING & RECONNECTING CABLE. DIP SWITCHES DO NOT NEED ALTERING.

DO NOT POWER THE SPA POOL BEFORE IT HAS BEEN FILLED

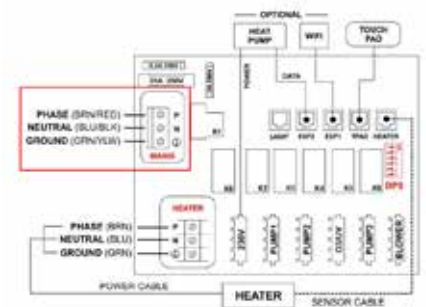
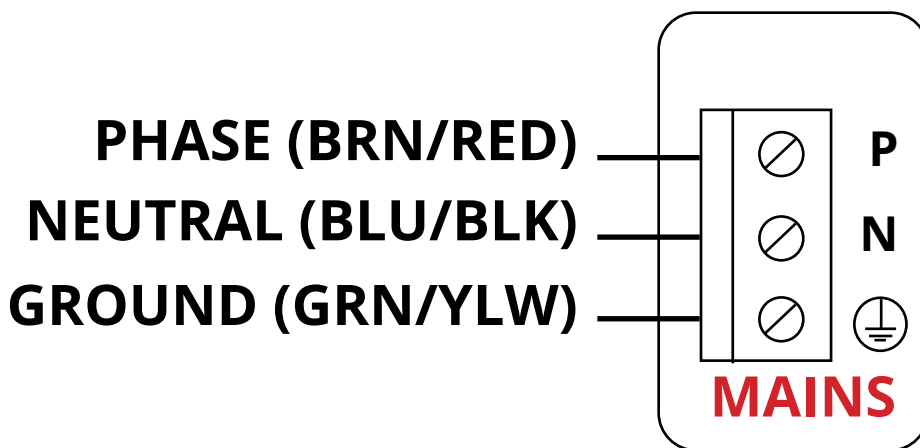

To setup for high amp (25A, no load shed*) see page 17 for information.

Locating the Controller & Cable

Remove the cabinet panels from the side of the spa pool that houses the system controller (see following page for exact location). Inside you will find the cable coiled up.





Identify labeled parts on pages 70 - 72



FRONT OF SPA

BELMONT SPA POOL OVERVIEW

Components:

Spa Pool Controller	SpaNet SV MINI-2
Topside Control Panel	SpaNet SV MINI-1
Heater Element	3KW
Pumps	Two-Speed Pump (3HP) (Circulation & Jet Massage)
Skimmer/Filter Type	Floating Weir
Sanitisers	Ozone
Electrical Info	15A/25A 230 - 240V AC 50hz IPX5
Cable	15amp Cable Pre-Connected

Cable & Wiring:

This 15amp spa pool includes a 4.5metre 15amp power cable that has been pre-connected and installed onto the system controller.



BELOW DIAGRAM IS FOR SINGLE PHASE 15A AND IS ONLY REQUIRED IF DISCONNECTING & RECONNECTING CABLE. DIP SWITCHES DO NOT NEED ALTERING.

DO NOT POWER THE SPA POOL BEFORE IT HAS BEEN FILLED

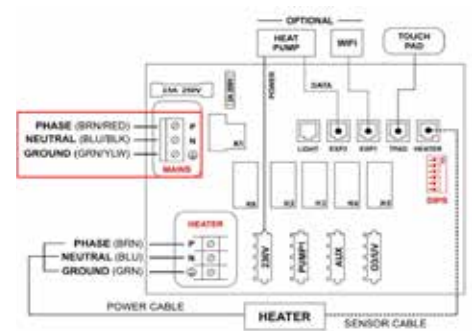
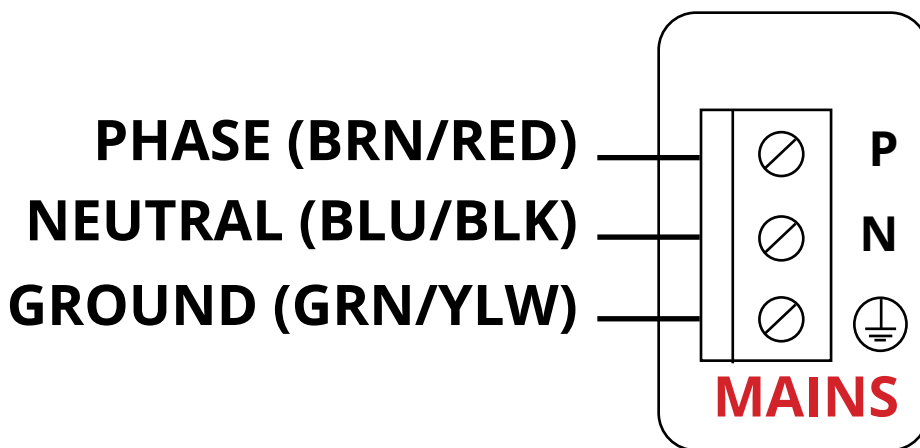

To setup for high amp (25A, no load shed*) see page 17 for information.

Locating the Controller & Cable

Remove the cabinet panels from the side of the spa pool that houses the system controller (see following page for exact location). Inside you will find the cable coiled up.





Identify labeled parts on pages 70 - 72

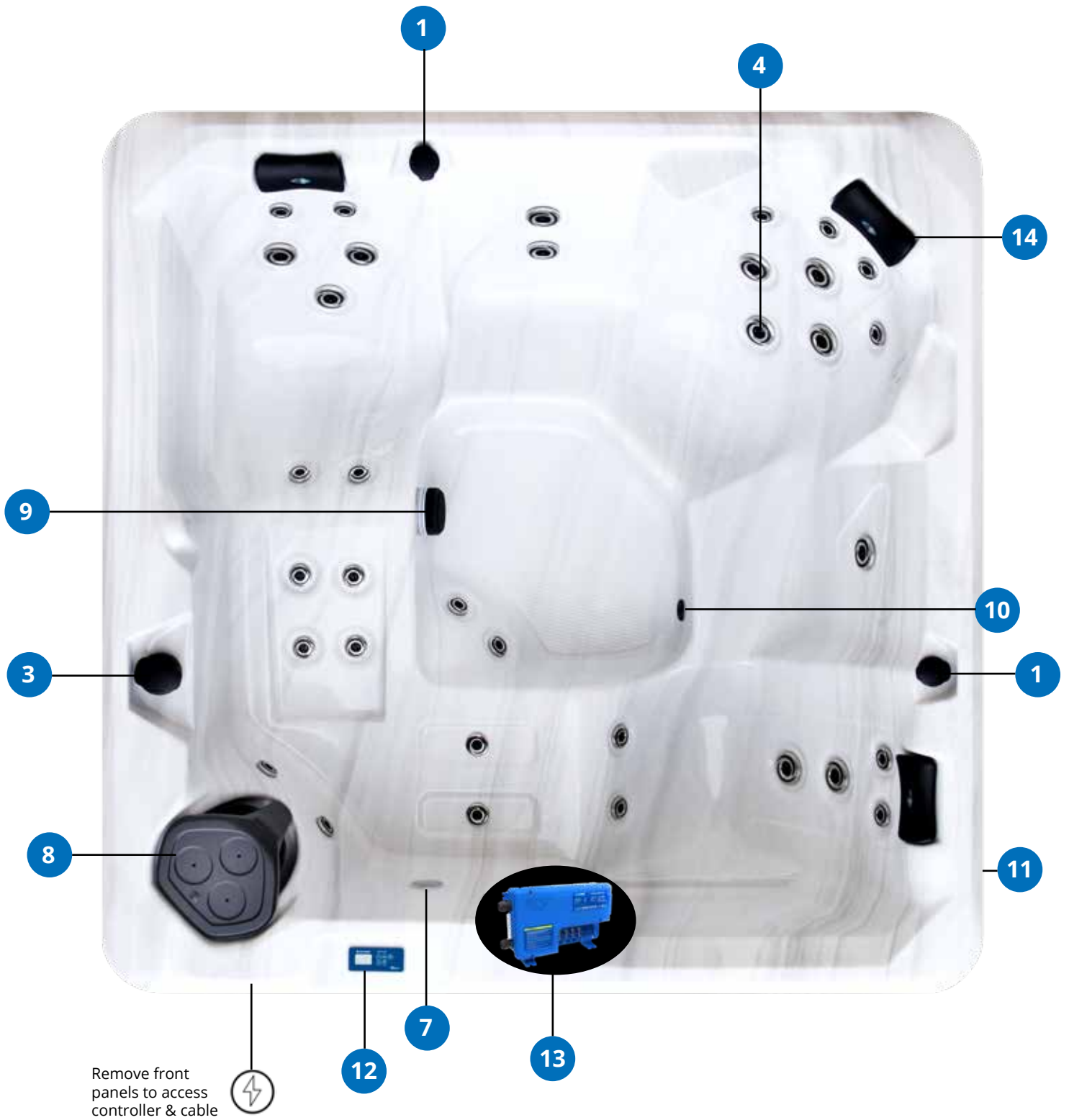

FRONT OF SPA

OREGON SPA POOL OVERVIEW

Components:

Spa Pool Controller	SpaNet SV MINI-2
Topside Control Panel	SpaNet SV MINI-1
Heater Element	3KW
Pumps	Two-Speed Pump (3HP) (Circulation & Jet Massage)
Skimmer/Filter Type	Floating Weir
Sanitisers	Ozone
Electrical Info	15A/25A 230 - 240V AC 50hz IPX5
Cable	15amp Cable Pre-Connected

Cable & Wiring:

This 15amp spa pool includes a 4.5metre 15amp power cable that has been pre-connected and installed onto the system controller.



BELOW DIAGRAM IS FOR SINGLE PHASE 15A AND IS ONLY REQUIRED IF DISCONNECTING & RECONNECTING CABLE. DIP SWITCHES DO NOT NEED ALTERING.

DO NOT POWER THE SPA POOL BEFORE IT HAS BEEN FILLED

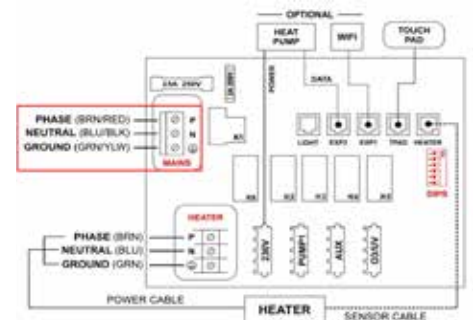
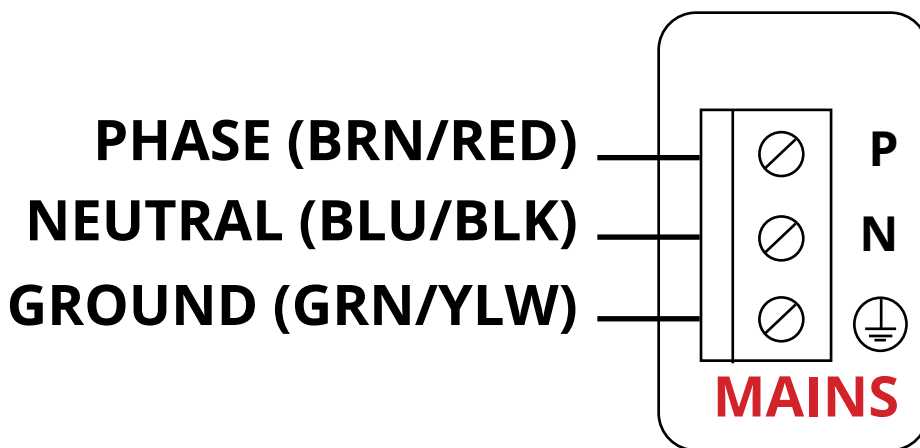

To setup for high amp (25A, no load shed*) see page 17 for information.

Locating the Controller & Cable

Remove the cabinet panels from the side of the spa pool that houses the system controller (see following page for exact location). Inside you will find the cable coiled up.





Identify labeled parts on pages 70 - 72

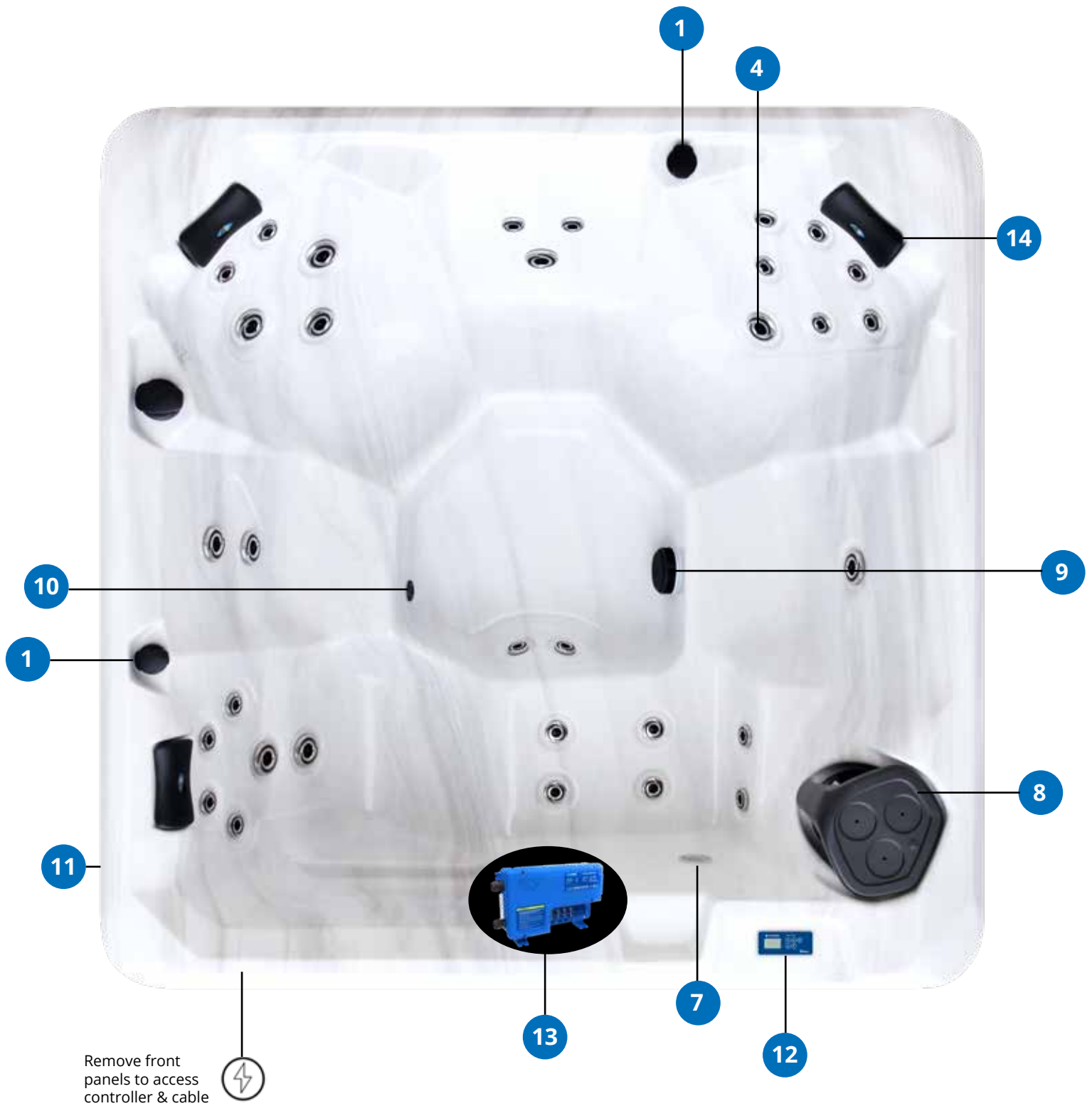

FRONT OF SPA

NEPAL SPA POOL OVERVIEW

Components:

Spa Pool Controller	SpaNet SV-SMART
Topside Control Panel	SpaNet SV-SMART
Heater Element	3KW
Pumps	1x Circulation Pump + 1x Jet Massage Pump (2HP)
Skimmer/Filter Type	Floating Weir
Sanitisers	UV-C & Ozone
Electrical Info	15A/25A 230 - 240V AC 50hz IPX5
Cable	15amp Cable Pre-Connected

Cable & Wiring:

This 15amp spa pool includes a 4.5metre 15amp power cable that has been pre-connected and installed onto the system controller.



BELOW DIAGRAM IS FOR SINGLE PHASE 15A AND IS ONLY REQUIRED IF DISCONNECTING & RECONNECTING CABLE. DIP SWITCHES DO NOT NEED ALTERING.

DO NOT POWER THE SPA POOL BEFORE IT HAS BEEN FILLED

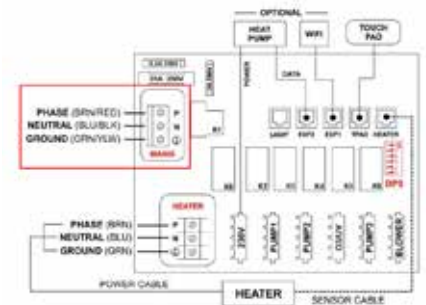
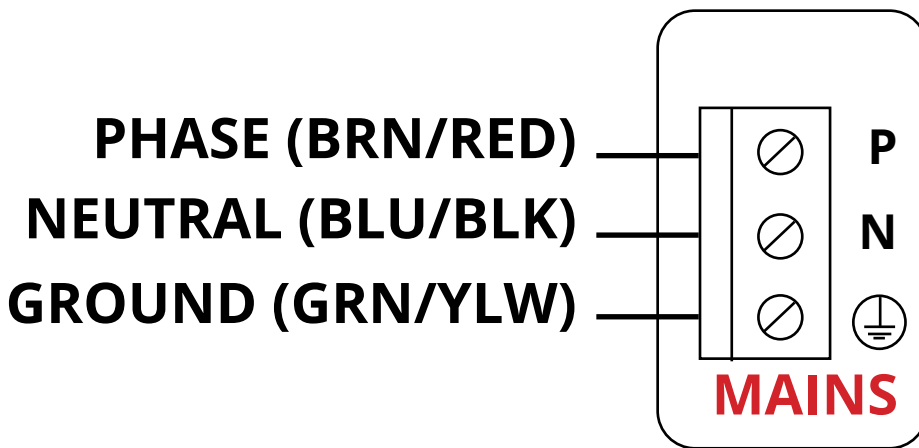

To setup for high amp (25A, no load shed*) see page 17 for information.

Locating the Controller & Cable

Remove the cabinet panels from the side of the spa pool that houses the system controller (see following page for exact location). Inside you will find the cable coiled up.





Identify labeled parts on pages 70 - 72

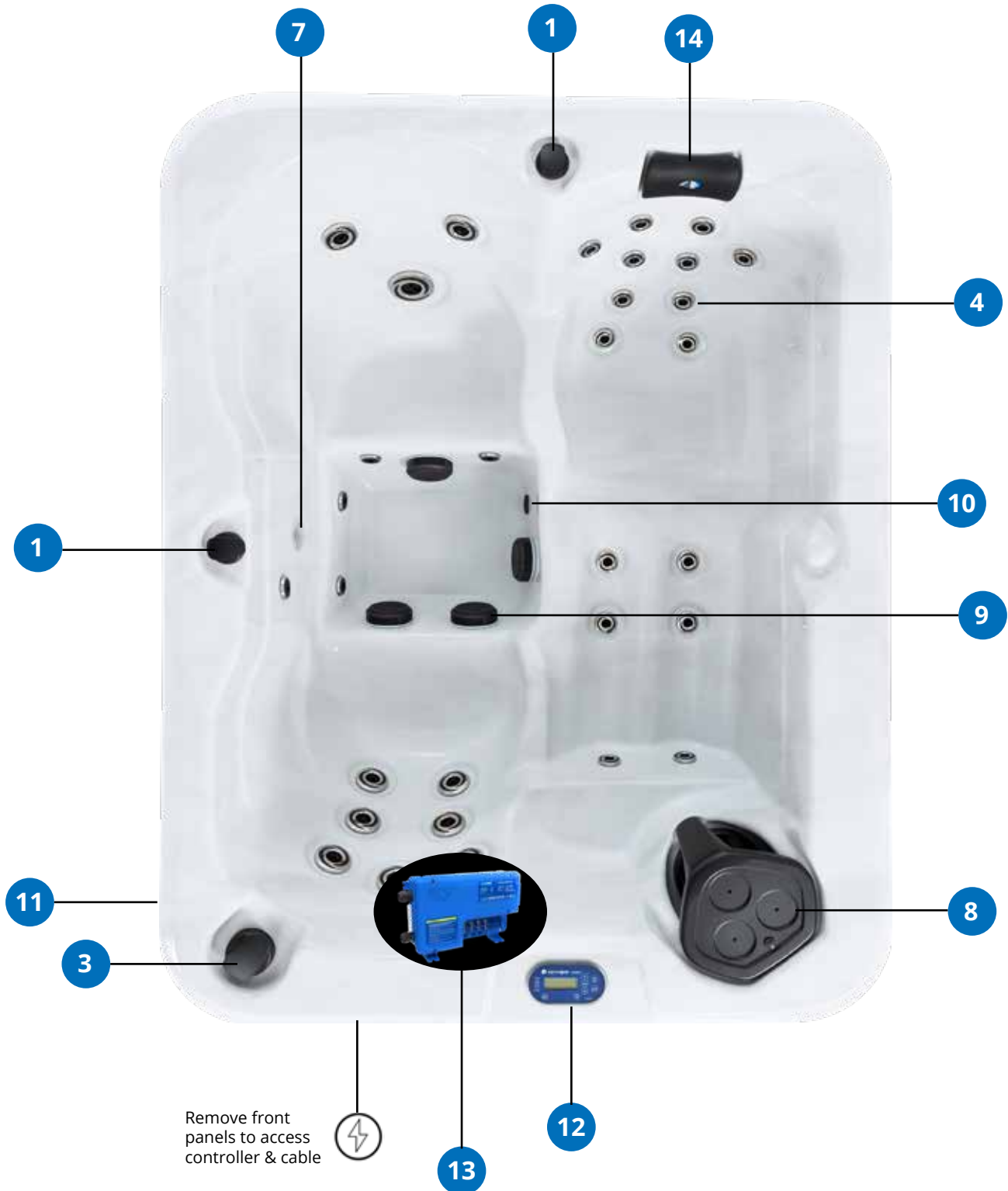

NORDIC SPA POOL OVERVIEW

Components:

Spa Pool Controller	SpaNet SV-SMART
Topside Control Panel	SpaNet SV-SMART
Heater Element	3KW
Pumps	1x Circulation Pump + 1x Jet Massage Pump (3HP)
Skimmer/Filter Type	Floating Weir
Sanitisers	UV-C & Ozone
Electrical Info	15A/25A 230 - 240V AC 50hz IPX5
Cable	15amp Cable Pre-Connected

Cable & Wiring:

This 15amp spa pool includes a 4.5metre 15amp power cable that has been pre-connected and installed onto the system controller.



BELOW DIAGRAM IS FOR SINGLE PHASE 15A AND IS ONLY REQUIRED IF DISCONNECTING & RECONNECTING CABLE. DIP SWITCHES DO NOT NEED ALTERING.

DO NOT POWER THE SPA POOL BEFORE IT HAS BEEN FILLED

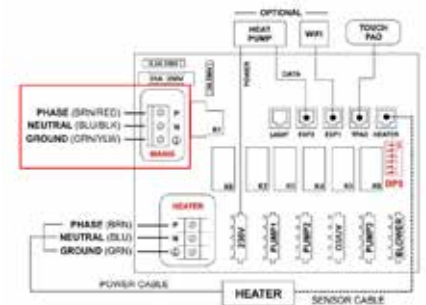
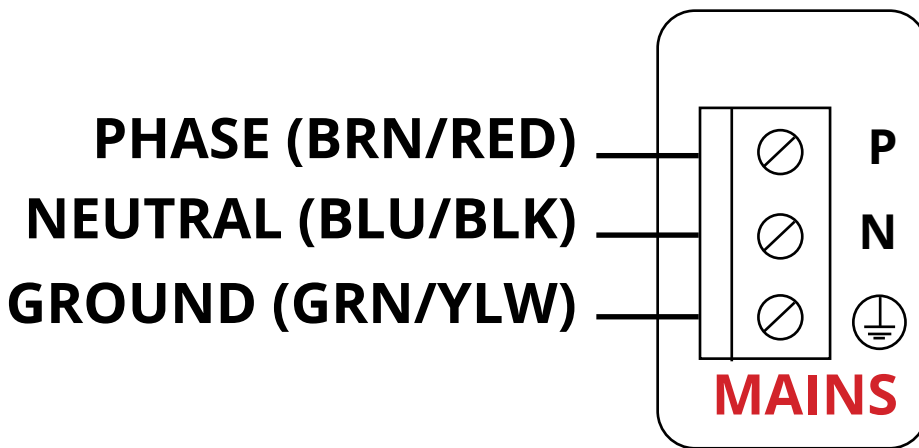

To setup for high amp (25A, no load shed*) see page 17 for information.

Locating the Controller & Cable

Remove the cabinet panels from the side of the spa pool that houses the system controller (see following page for exact location). Inside you will find the cable coiled up.





Identify labeled parts on pages 70 - 72

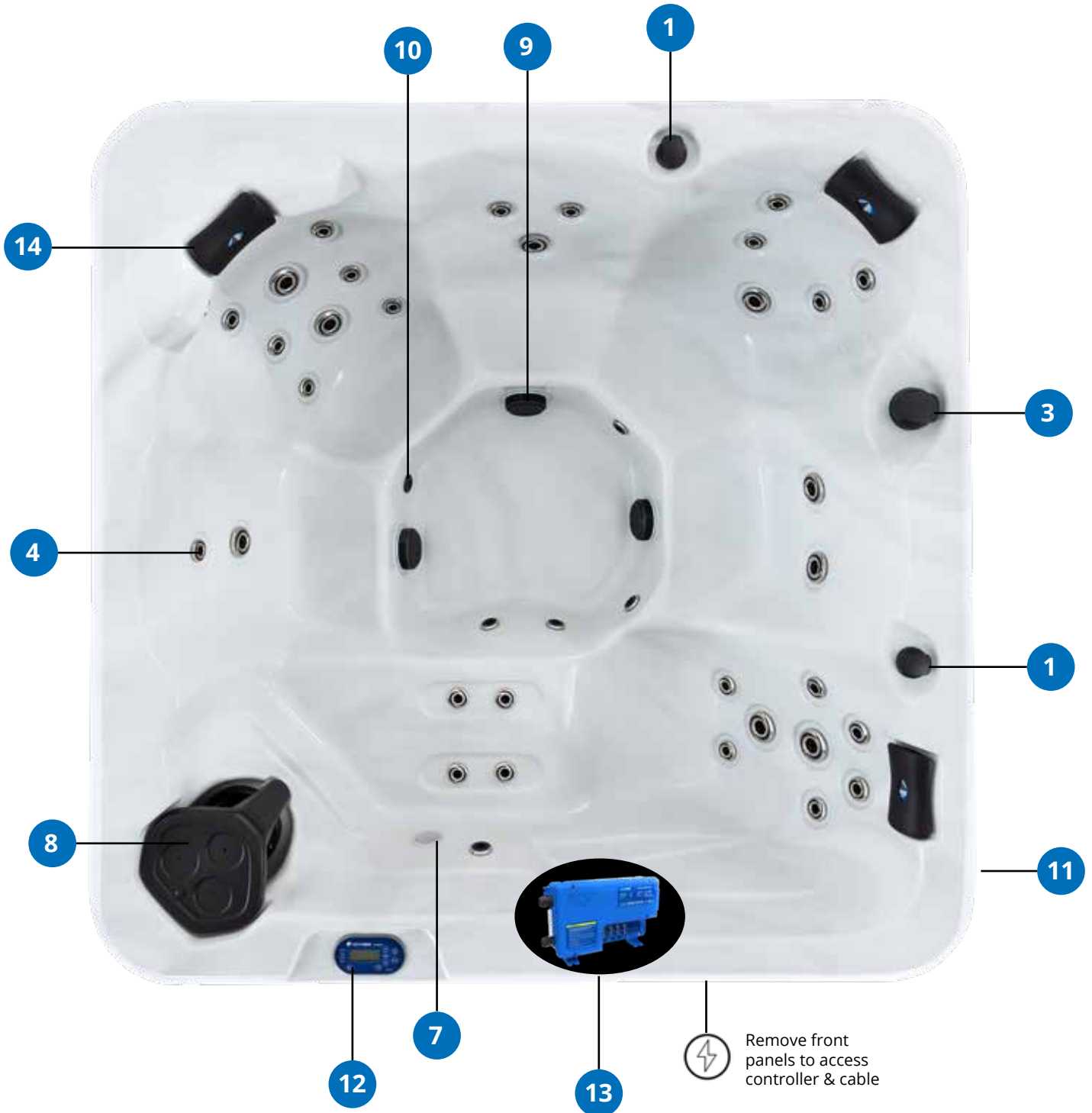

FRONT OF SPA

ASPEN SPA POOL OVERVIEW

Components:

Spa Pool Controller	SpaNet SV-SMART
Topside Control Panel	SpaNet SV-SMART
Heater Element	3KW
Pumps	1x Circulation Pump + 1x Jet Massage Pump (3HP)
Skimmer/Filter Type	Floating Weir
Sanitisers	UV-C & Ozone
Electrical Info	15A/25A 230 - 240V AC 50hz IPX5
Cable	15amp Cable Pre-Connected

Cable & Wiring:

This 15amp spa pool includes a 4.5metre 15amp power cable that has been pre-connected and installed onto the system controller.



BELOW DIAGRAM IS FOR SINGLE PHASE 15A AND IS ONLY REQUIRED IF DISCONNECTING & RECONNECTING CABLE. DIP SWITCHES DO NOT NEED ALTERING.

DO NOT POWER THE SPA POOL BEFORE IT HAS BEEN FILLED

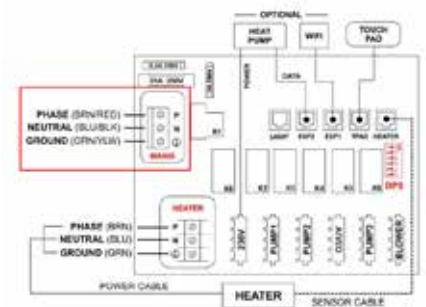
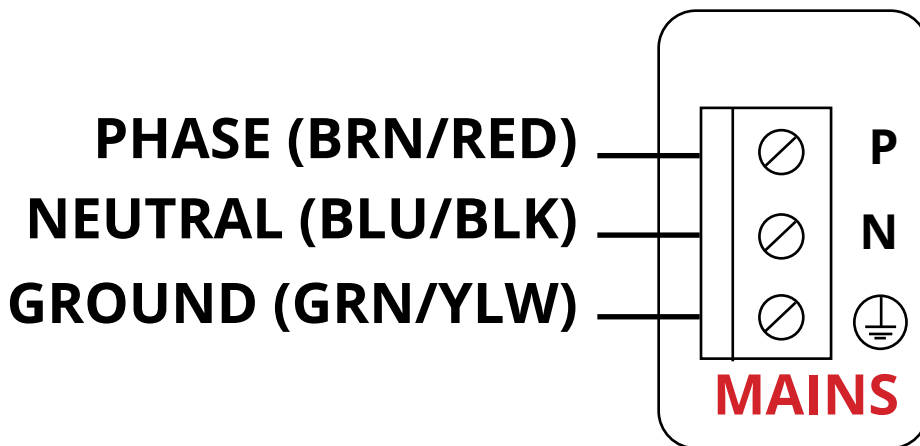

To setup for high amp (25A, no load shed*) see page 17 for information.

Locating the Controller & Cable

Remove the cabinet panels from the side of the spa pool that houses the system controller (see following page for exact location). Inside you will find the cable coiled up.





Identify labeled parts on pages 70 - 72

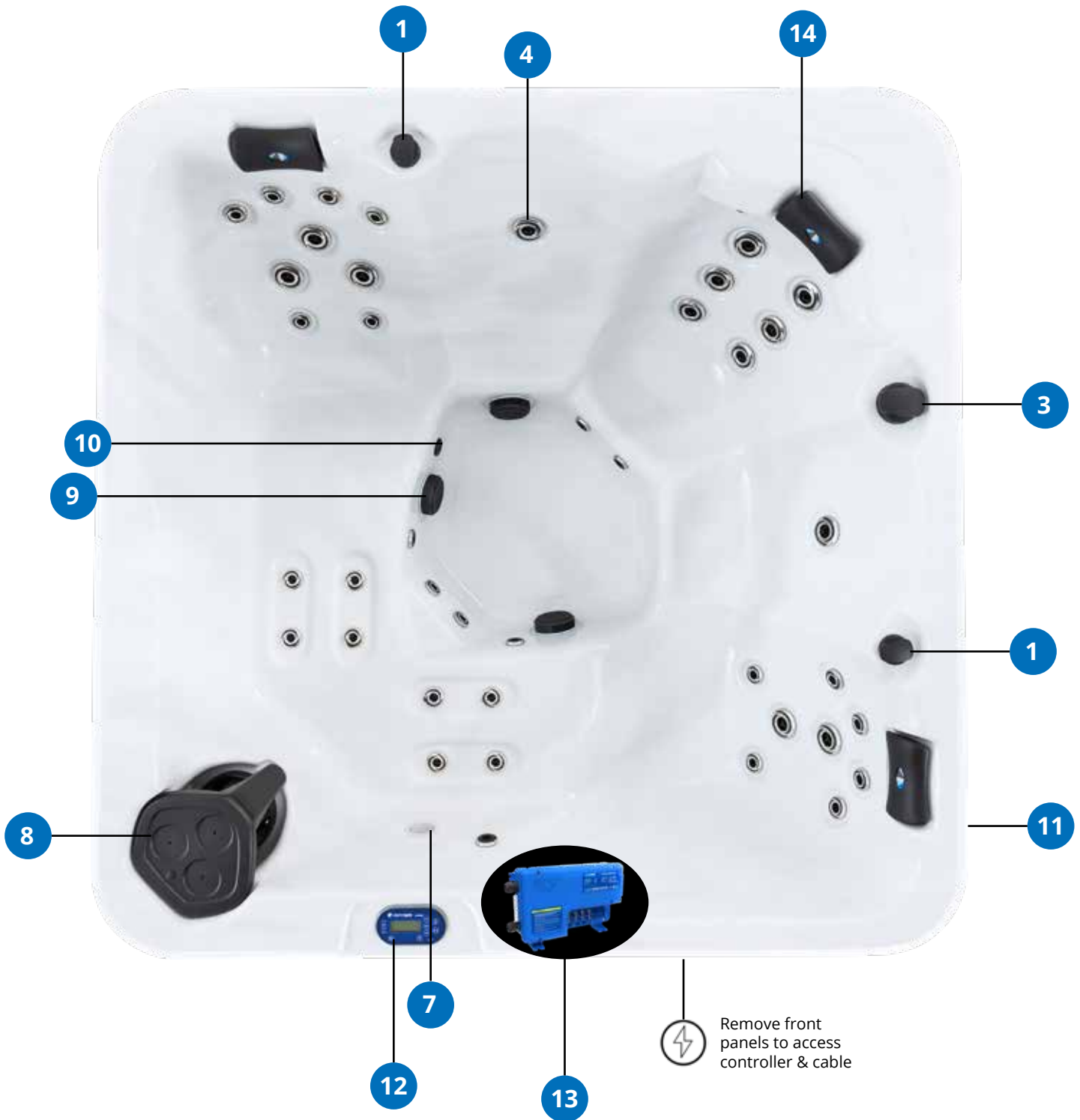

FRONT OF SPA

YUKON SPA POOL OVERVIEW

Components:

Spa Pool Controller	SpaNet SV-SMART
Topside Control Panel	SpaNet SV-SMART
Heater Element	3KW
Pumps	1x Circulation Pump + 1x Jet Massage Pump (3HP)
Skimmer/Filter Type	Floating Weir
Sanitisers	UV-C & Ozone
Electrical Info	15A/25A 230 - 240V AC 50hz IPX5
Cable	15amp Cable Pre-Connected

Cable & Wiring:

This 15amp spa pool includes a 4.5metre 15amp power cable that has been pre-connected and installed onto the system controller.



BELOW DIAGRAM IS FOR SINGLE PHASE 15A AND IS ONLY REQUIRED IF DISCONNECTING & RECONNECTING CABLE. DIP SWITCHES DO NOT NEED ALTERING.

DO NOT POWER THE SPA POOL BEFORE IT HAS BEEN FILLED

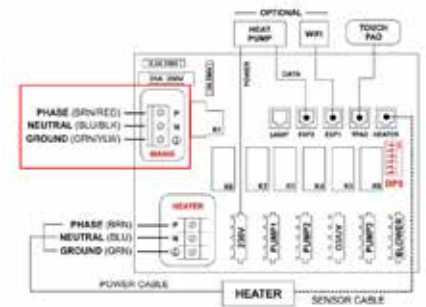
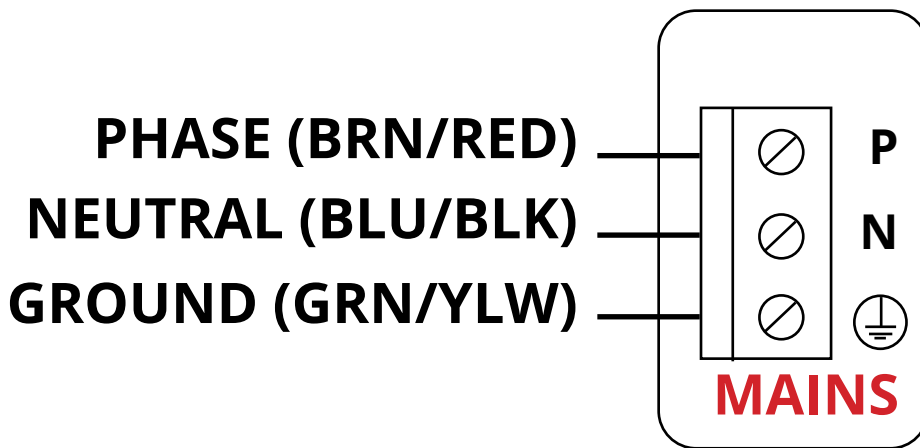

To setup for high amp (25A, no load shed*) see page 17 for information.

Locating the Controller & Cable

Remove the cabinet panels from the side of the spa pool that houses the system controller (see following page for exact location). Inside you will find the cable coiled up.





Identify labeled parts on pages 70 - 72

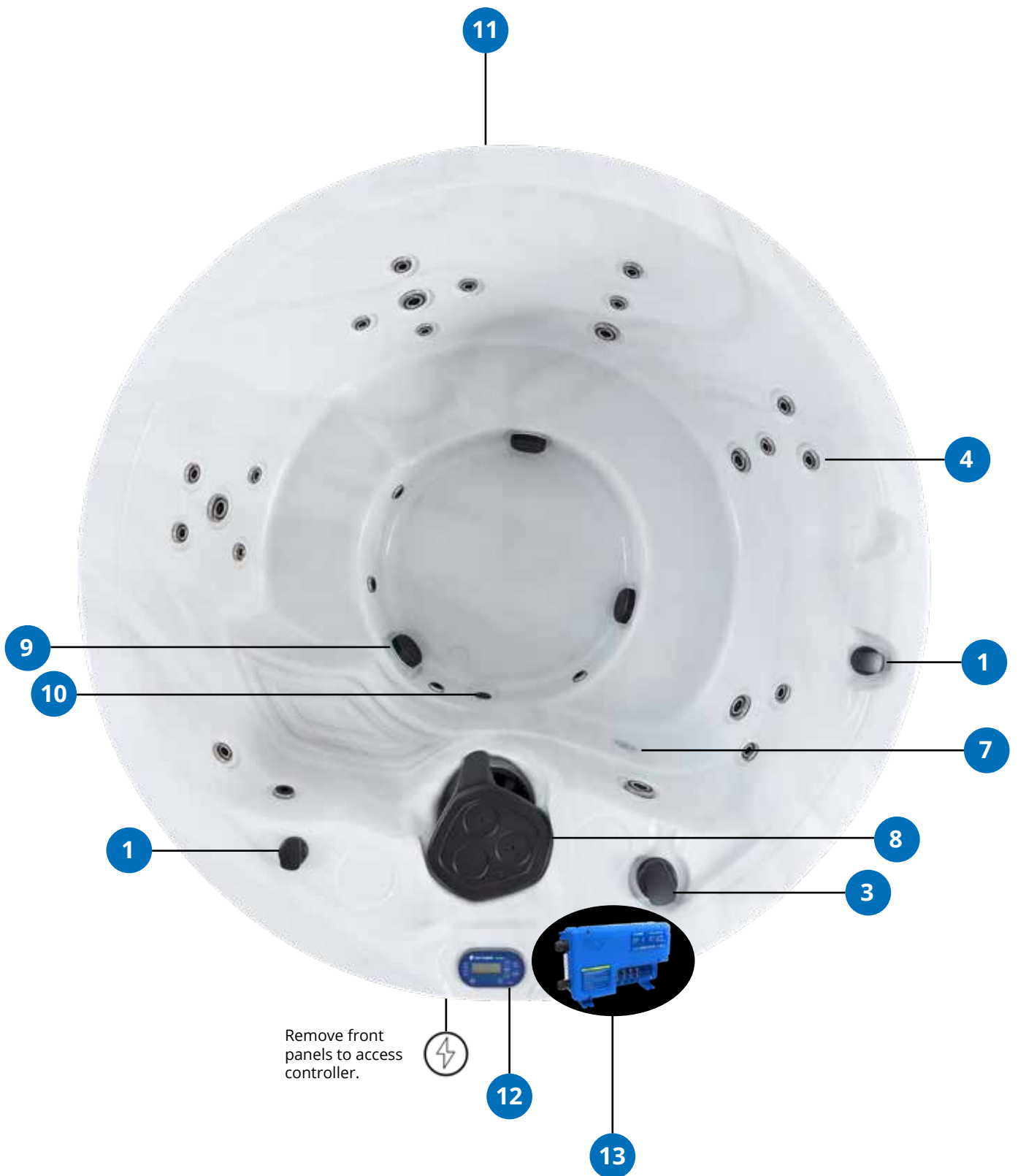

FRONT OF SPA

VERMONT SPA POOL OVERVIEW

Components:

Spa Pool Controller	SpaNet SV-SMART
Topside Control Panel	SpaNet SmartTouch
Heater Element	3KW
Pumps	1x Circulation Pump + 1x Jet Massage Pump (3HP)
Skimmer/Filter Type	Open-Top Skimmer
Sanitisers	UV-C & Ozone
Electrical Info	15A/25A 230 - 240V AC 50hz IPX5
Cable	15amp Cable Pre-Connected

Cable & Wiring:

This 15amp spa pool includes a 4.5metre 15amp power cable that has been pre-connected and installed onto the system controller.



BELOW DIAGRAM IS FOR SINGLE PHASE 15A AND IS ONLY REQUIRED IF DISCONNECTING & RECONNECTING CABLE. DIP SWITCHES DO NOT NEED ALTERING.

DO NOT POWER THE SPA POOL BEFORE IT HAS BEEN FILLED

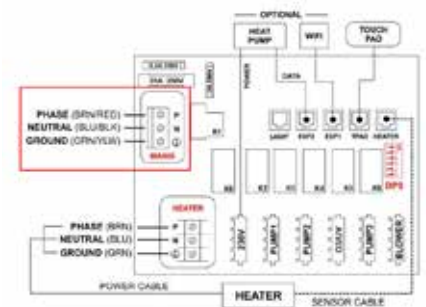
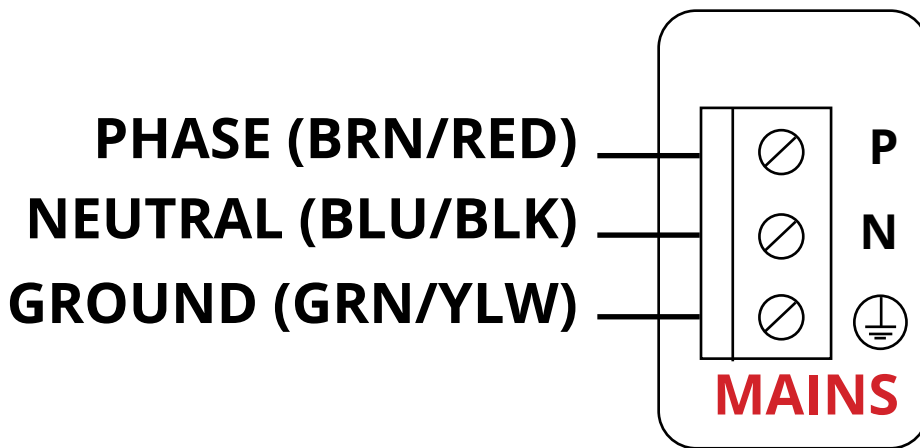

To setup for high amp (25A, no load shed*) see page 17 for information.

Locating the Controller & Cable

Remove the cabinet panels from the side of the spa pool that houses the system controller (see following page for exact location). Inside you will find the cable coiled up.





Identify labeled parts on pages 70 - 72

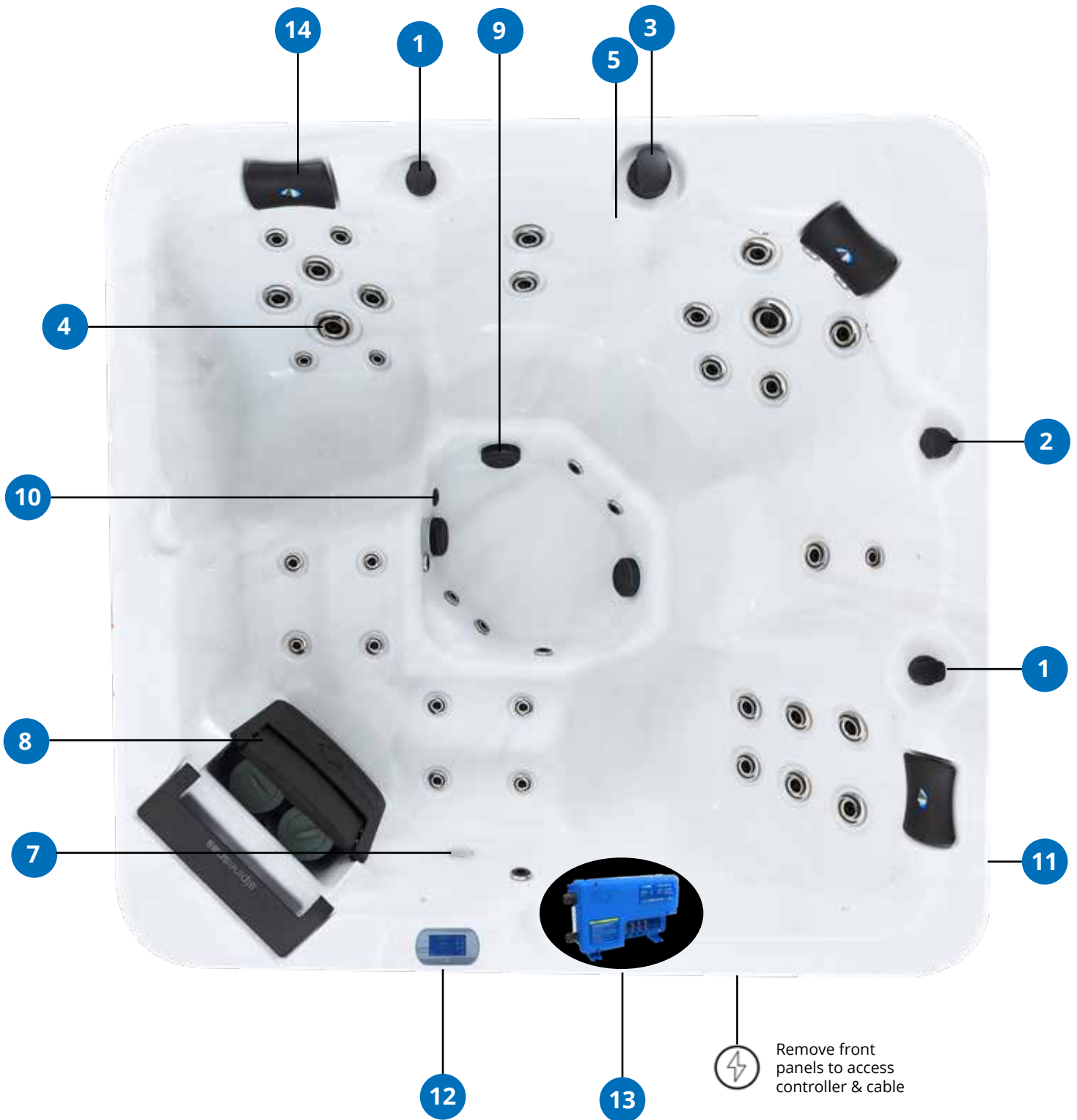

FRONT OF SPA

NEVADA SPA POOL OVERVIEW

Components:

Spa Pool Controller	SpaNet SV-SMART
Topside Control Panel	SpaNet SmartTouch
Heater Element	3KW
Pumps	1x Circulation Pump + 1x Jet Massage Pump (3HP)
Skimmer/Filter Type	Floating Weir
Sanitisers	UV-C & Ozone
Electrical Info	15A/25A 230 - 240V AC 50hz IPX5
Cable	15amp Cable Pre-Connected

Cable & Wiring:

This 15amp spa pool includes a 4.5metre 15amp power cable that has been pre-connected and installed onto the system controller.



BELOW DIAGRAM IS FOR SINGLE PHASE 15A AND IS ONLY REQUIRED IF DISCONNECTING & RECONNECTING CABLE. DIP SWITCHES DO NOT NEED ALTERING.

DO NOT POWER THE SPA POOL BEFORE IT HAS BEEN FILLED

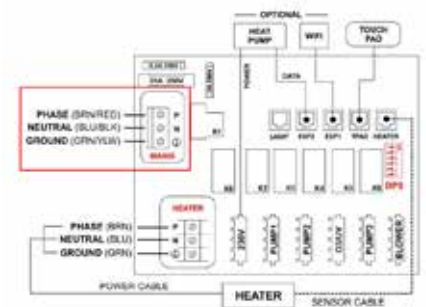
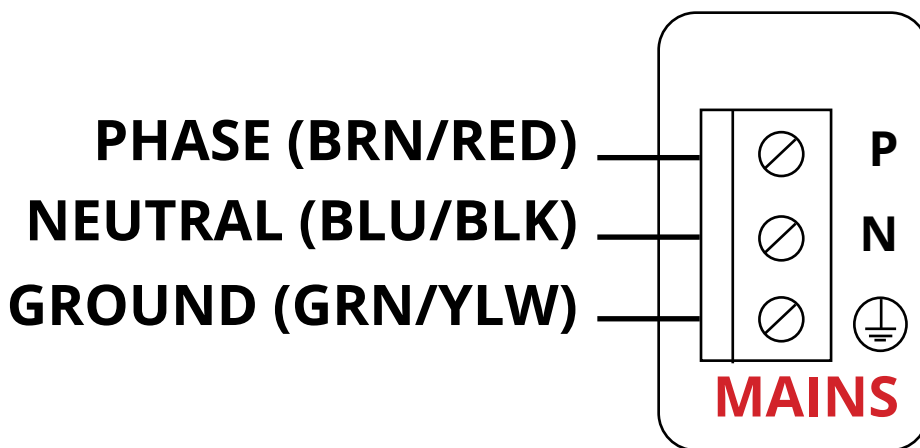

To setup for high amp (25A, no load shed*) see page 17 for information.

Locating the Controller & Cable

Remove the cabinet panels from the side of the spa pool that houses the system controller (see following page for exact location). Inside you will find the cable coiled up.





Identify labeled parts on pages 70 - 72

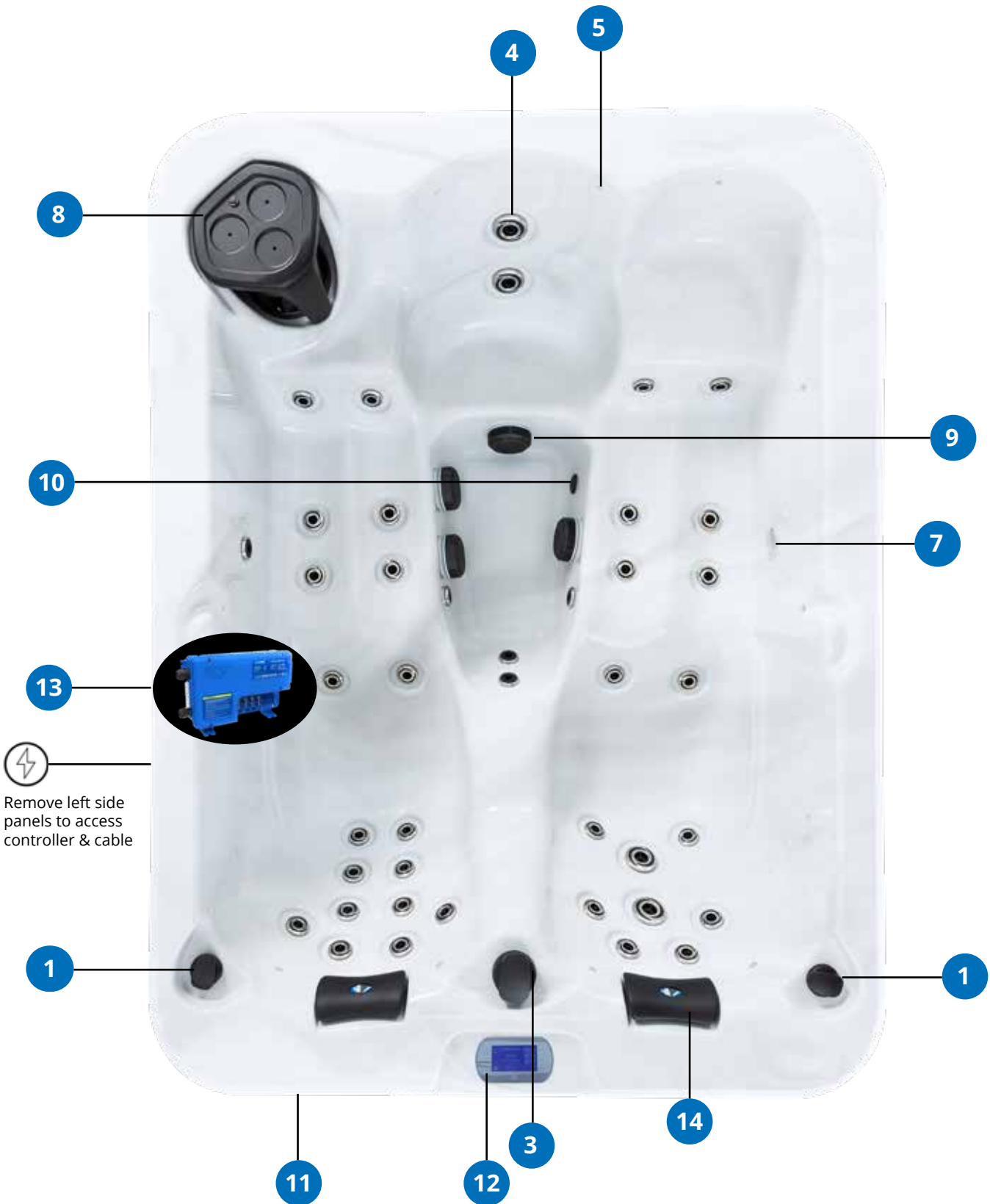

FRONT OF SPA

MATTERHORN SPA POOL OVERVIEW

Components:

Spa Pool Controller	SpaNet SV-SMART
Topside Control Panel	SpaNet SmartTouch
Heater Element	3KW
Pumps	1x Circulation Pump + 1x Jet Massage Pump (3HP)
Skimmer/Filter Type	Open-Top Skimmer
Sanitisers	UV-C & Ozone
Electrical Info	15A/25A 230 - 240V AC 50hz IPX5
Cable	15amp Cable Pre-Connected

Cable & Wiring:

This 15amp spa pool includes a 4.5metre 15amp power cable that has been pre-connected and installed onto the system controller.



BELOW DIAGRAM IS FOR SINGLE PHASE 15A AND IS ONLY REQUIRED IF DISCONNECTING & RECONNECTING CABLE. DIP SWITCHES DO NOT NEED ALTERING.

DO NOT POWER THE SPA POOL BEFORE IT HAS BEEN FILLED

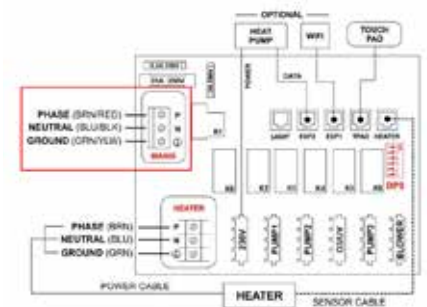
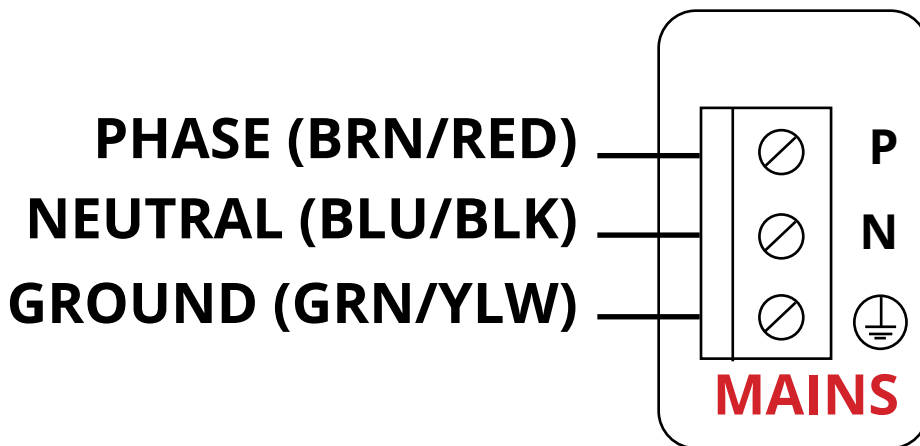

To setup for high amp (25A, no load shed*) see page 17 for information.

Locating the Controller & Cable

Remove the cabinet panels from the side of the spa pool that houses the system controller (see following page for exact location). Inside you will find the cable coiled up.





Identify labeled parts on pages 70 - 72

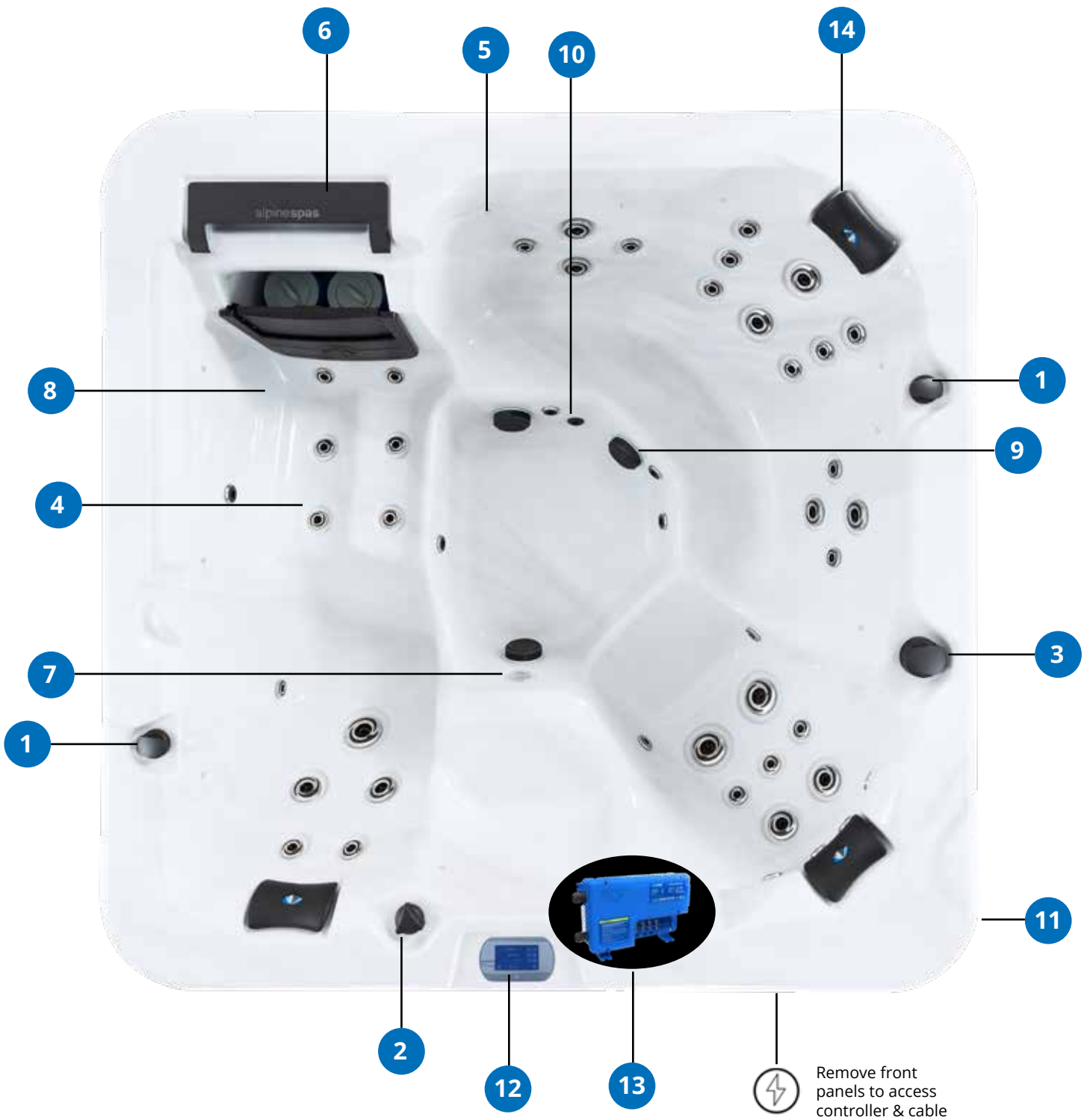

FRONT OF SPA

LUCANIA SPA POOL OVERVIEW

Components:

Spa Pool Controller	SpaNet SV-SMART
Topside Control Panel	SpaNet SV-SMART
Heater Element	3KW
Pumps	1x Circulation Pump + 1x Jet Massage Pump (3HP)
Skimmer/Filter Type	Open-Top Skimmer
Sanitisers	UV-C & Ozone
Electrical Info	15A/25A 230 - 240V AC 50hz IPX5
Cable	15amp Cable Pre-Connected

Cable & Wiring:

This 15amp spa pool includes a 4.5metre 15amp power cable that has been pre-connected and installed onto the system controller.



BELOW DIAGRAM IS FOR SINGLE PHASE 15A AND IS ONLY REQUIRED IF DISCONNECTING & RECONNECTING CABLE. DIP SWITCHES DO NOT NEED ALTERING.

DO NOT POWER THE SPA POOL BEFORE IT HAS BEEN FILLED

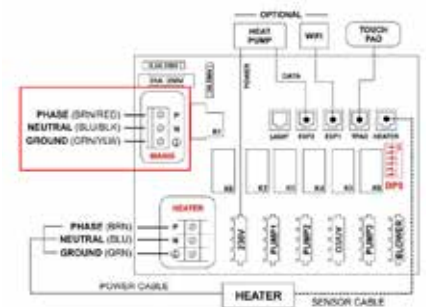
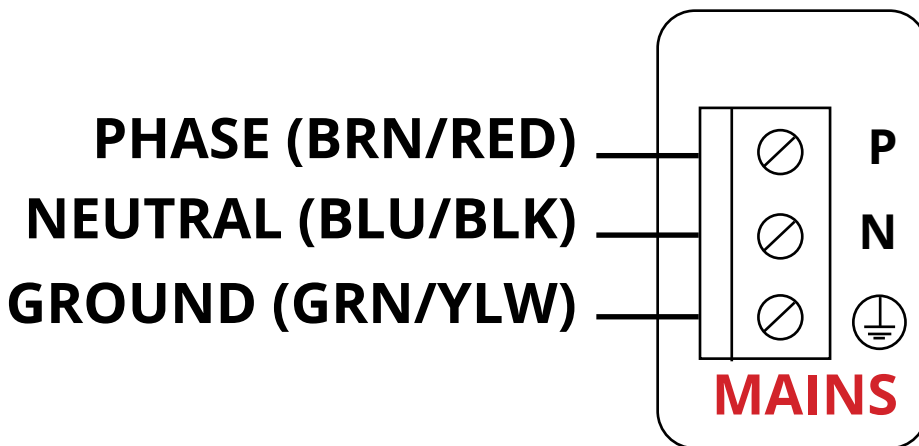

To setup for high amp (25A, no load shed*) see page 17 for information.

Locating the Controller & Cable

Remove the cabinet panels from the side of the spa pool that houses the system controller (see following page for exact location). Inside you will find the cable coiled up.





Identify labeled parts on pages 70 - 72

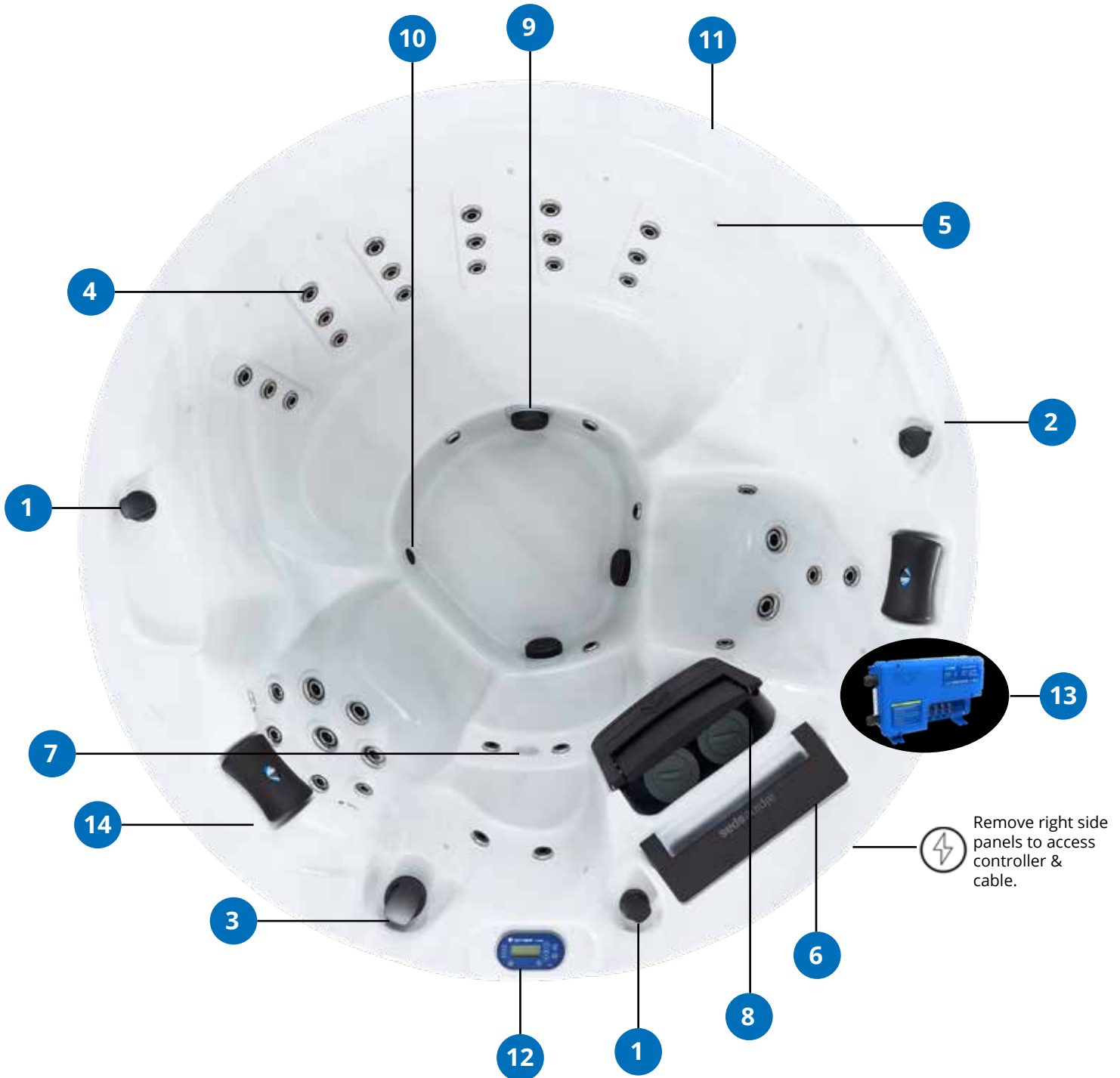

FRONT OF SPA

QUEBEC SPA POOL OVERVIEW

Components:

Spa Pool Controller	SpaNet SV-SMART
Topside Control Panel	SpaNet SmartTouch
Heater Element	3KW
Pumps	1x Circulation Pump + 1x Jet Massage Pump (3HP)
Skimmer/Filter Type	Open-Top Skimmer
Sanitisers	UV-C & Ozone
Electrical Info	15A/25A 230 - 240V AC 50hz IPX5
Cable	15amp Cable Pre-Connected

Cable & Wiring:

This 15amp spa pool includes a 4.5metre 15amp power cable that has been pre-connected and installed onto the system controller.



BELOW DIAGRAM IS FOR SINGLE PHASE 15A AND IS ONLY REQUIRED IF DISCONNECTING & RECONNECTING CABLE. DIP SWITCHES DO NOT NEED ALTERING.

DO NOT POWER THE SPA POOL BEFORE IT HAS BEEN FILLED

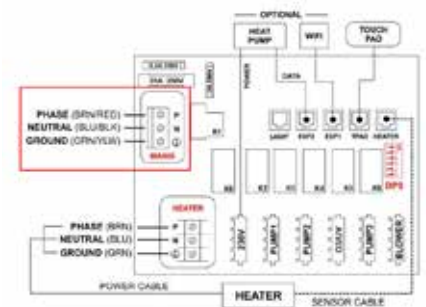
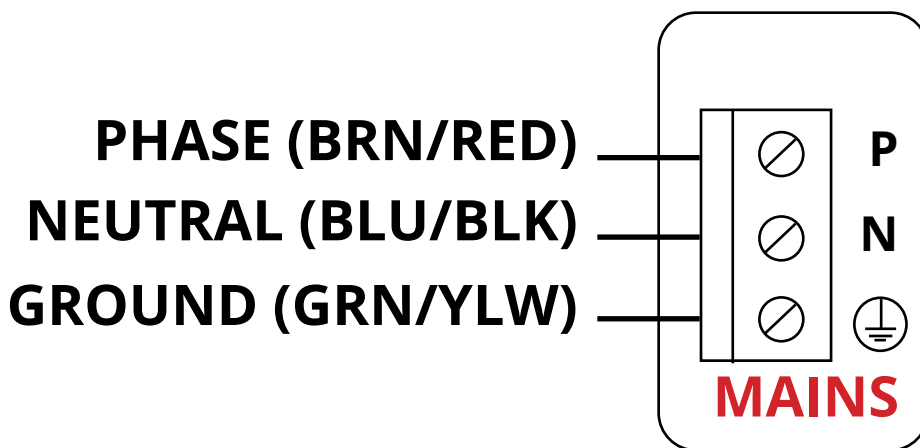

To setup for high amp (25A, no load shed*) see page 17 for information.

Locating the Controller & Cable

Remove the cabinet panels from the side of the spa pool that houses the system controller (see following page for exact location). Inside you will find the cable coiled up.





Identify labeled parts on pages 72 - 74

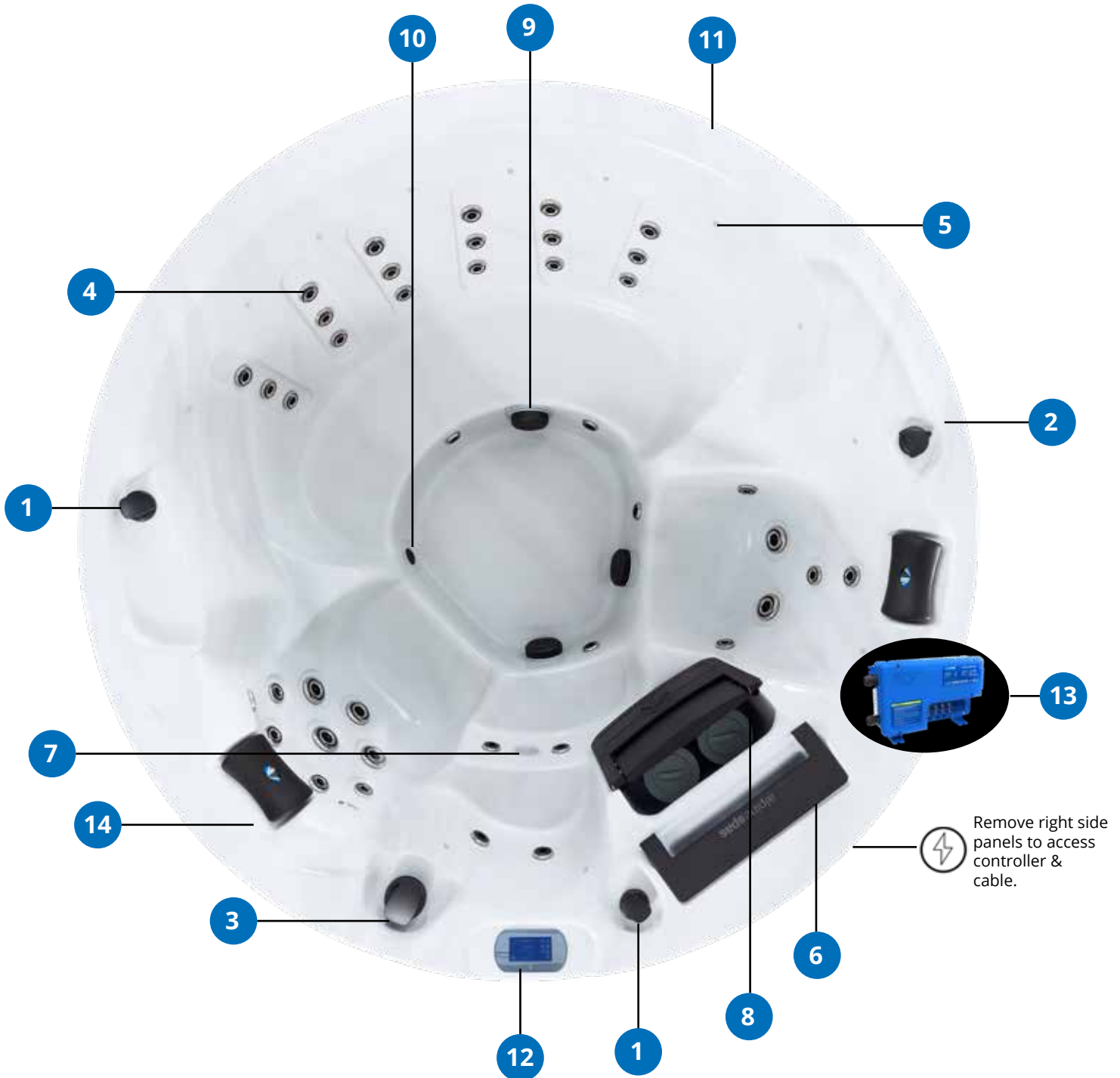

FRONT OF SPA

VANCOUVER SPA POOL OVERVIEW

Components:

Spa Pool Controller	SpaNet SV-SMART
Topside Control Panel	SpaNet SV-SMART
Heater Element	3KW
Pumps	1x Circulation Pump + 2x Jet Massage Pump (3HP)
Skimmer/Filter Type	Open-Top Skimmer
Sanitisers	UV-C & Ozone
Electrical Info	25A 230 - 240V AC 50hz IPX5
Cable	No Cable - Hardwiring Required.

Hardwire Required:

This spa pool requires direct hardwiring from the circuit board to the system controller with suitable electrical cable.



BELOW DIAGRAM IS FOR SINGLE PHASE 25A CONNECTION. DIP SWITCHES ARE PRESET & SHOULD NOT NEED ALTERING.

DO NOT POWER THE SPA POOL BEFORE IT HAS BEEN FILLED

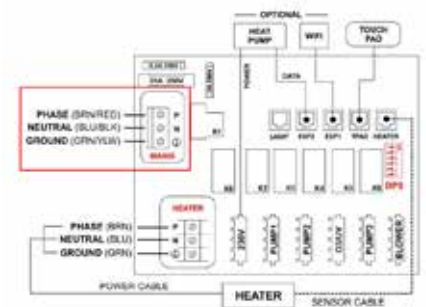
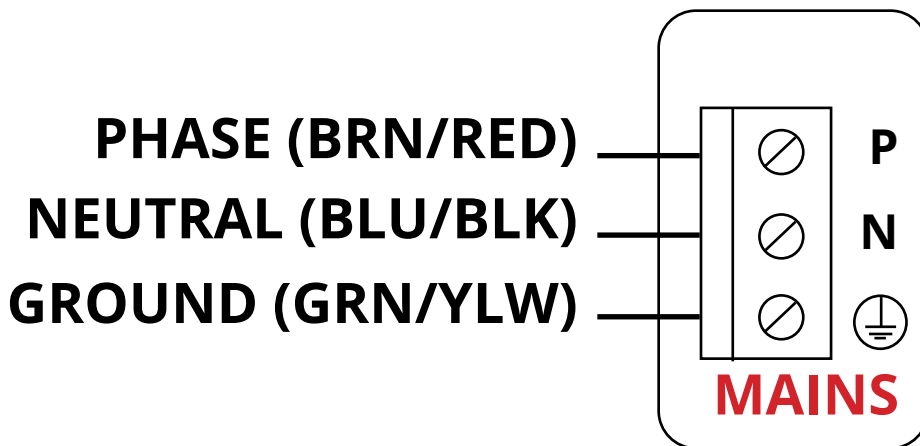

Locating the Controller

Remove the cabinet panels from the side of the spa pool that houses the controller (see following picture for exact location).





Identify labeled parts on pages 70 - 72

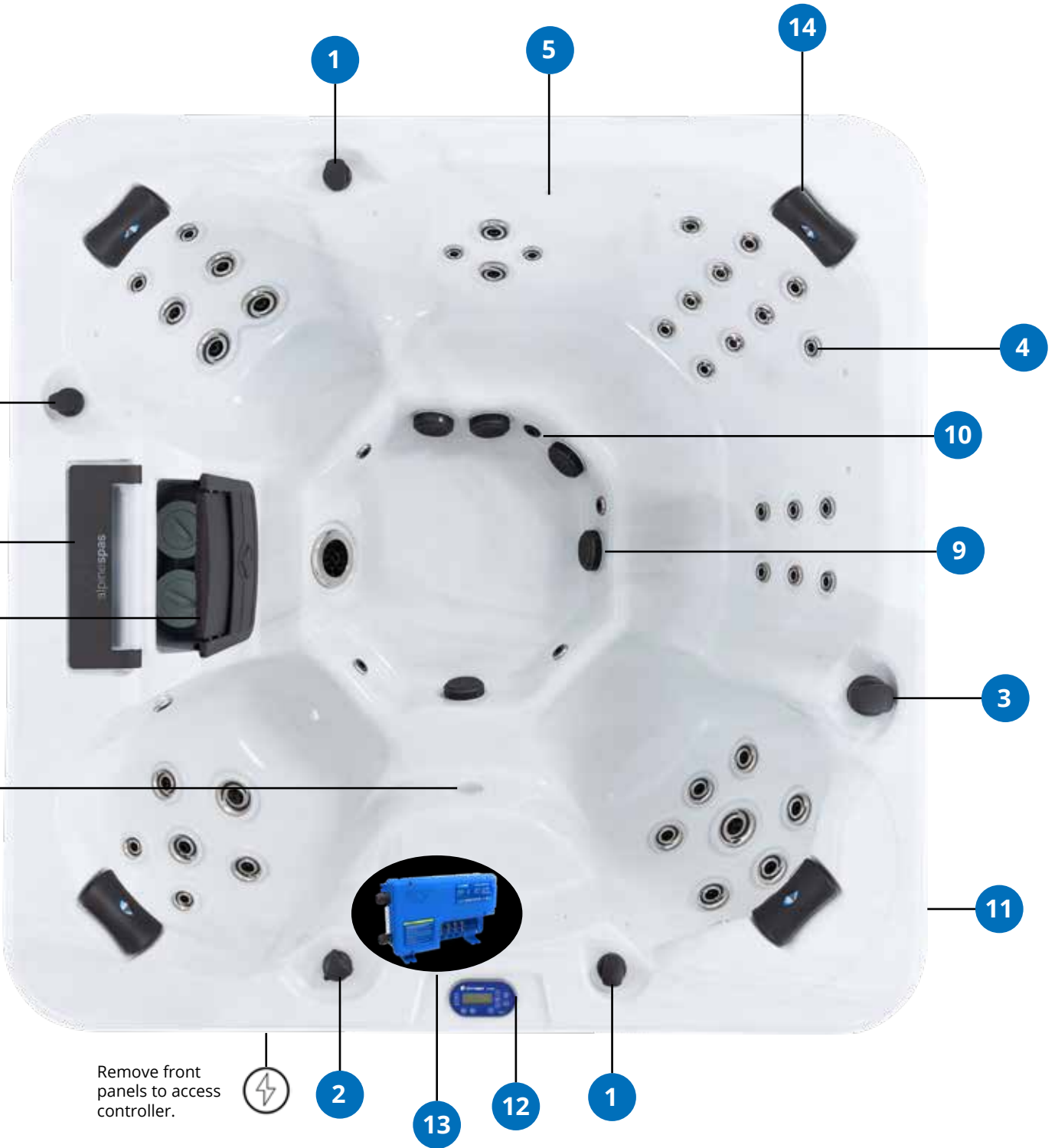

MUNRO SPA POOL OVERVIEW

Components:

Spa Pool Controller	SpaNet SV-SMART
Topside Control Panel	SpaNet SV-SMART
Heater Element	3KW
Pumps	1x Circulation Pump + 2x Jet Massage Pump (3HP)
Skimmer/Filter Type	Open-Top Skimmer
Sanitisers	UV-C & Ozone
Electrical Info	25A 230 - 240V AC 50hz IPX5
Cable	No Cable - Hardwiring Required.

Hardwire Required:

This spa pool requires direct hardwiring from the circuit board to the system controller with suitable electrical cable.



BELOW DIAGRAM IS FOR SINGLE PHASE 25A CONNECTION. DIP SWITCHES ARE PRESET & SHOULD NOT NEED ALTERING.

DO NOT POWER THE SPA POOL BEFORE IT HAS BEEN FILLED

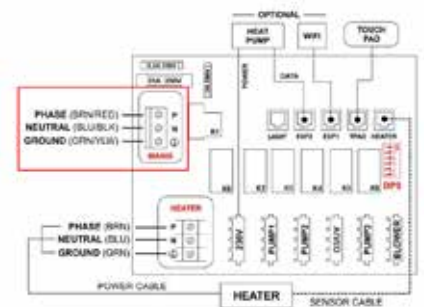
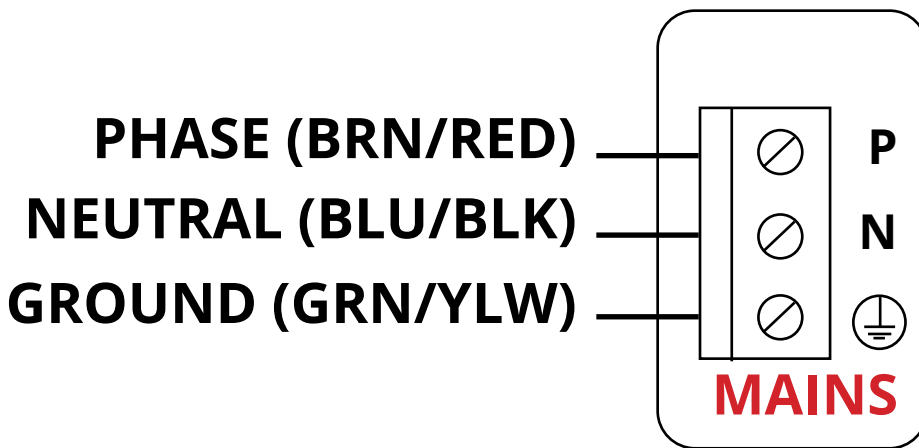

Locating the Controller

Remove the cabinet panels from the side of the spa pool that houses the controller (see following picture for exact location).





Identify labeled parts on pages 70 - 72

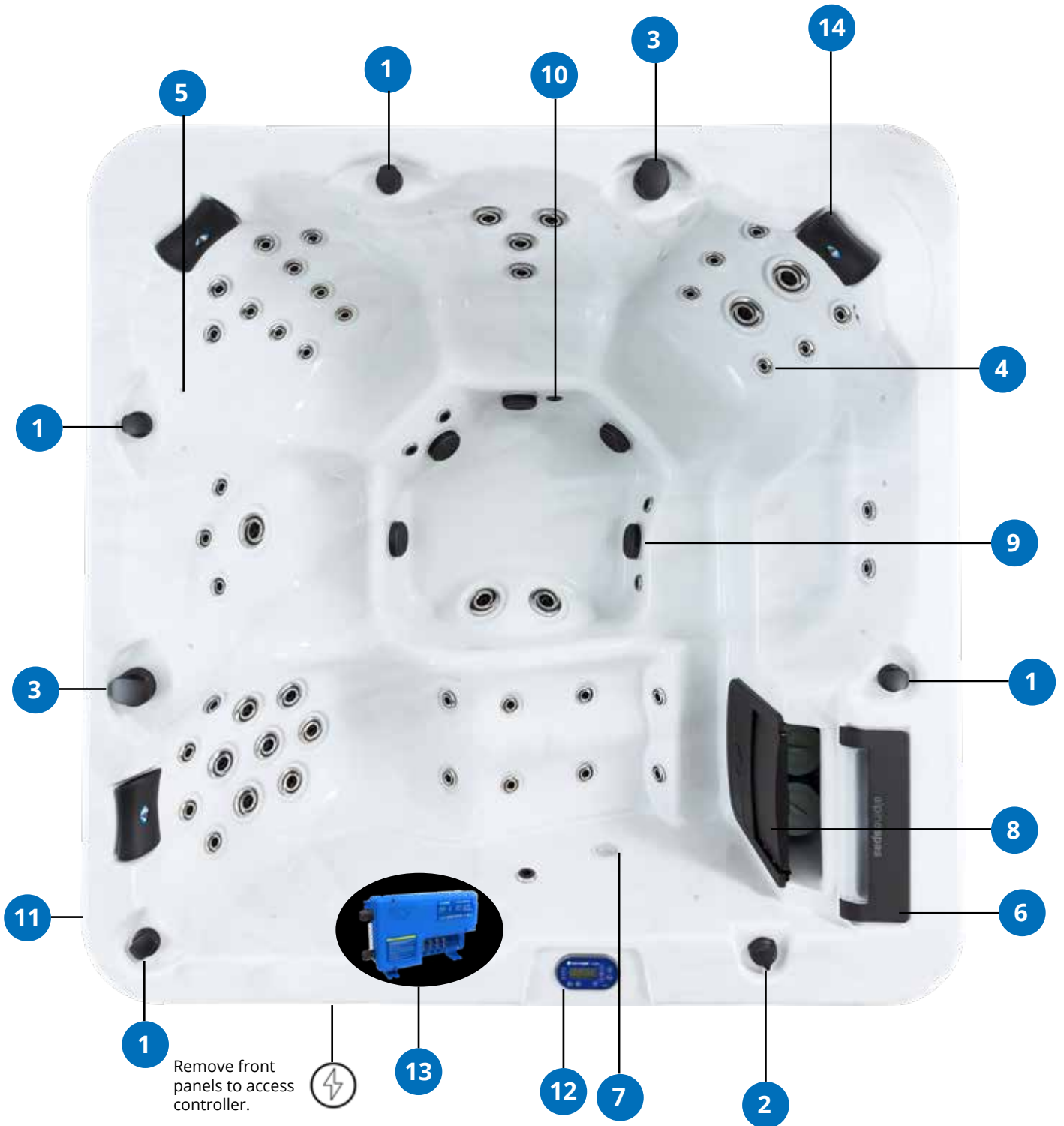

FRONT OF SPA

GRAND CANYON SPA POOL OVERVIEW

Components:

Spa Pool Controller	SpaNet SV3-VH
Topside Control Panel	SpaNet SmartTouch
Heater Element	6KW (Variable)
Pumps	1x Circulation Pump + 3x Jet Massage Pump (3HP)
Skimmer/Filter Type	Open-Top Skimmer
Sanitisers	UV-C & Ozone
Electrical Info	32A/45A 230 - 240V AC 50hz IPX5
Cable	No Cable Included - Hardwiring Required.

Hardwire Required:

This spa pool requires direct hardwiring from the circuit board to the system controller with suitable electrical cable.



**BELOW DIAGRAMS ARE FOR 32A CONNECTIONS.
DIP SWITCHES ARE PRESET FOR SINGLE PHASE.**

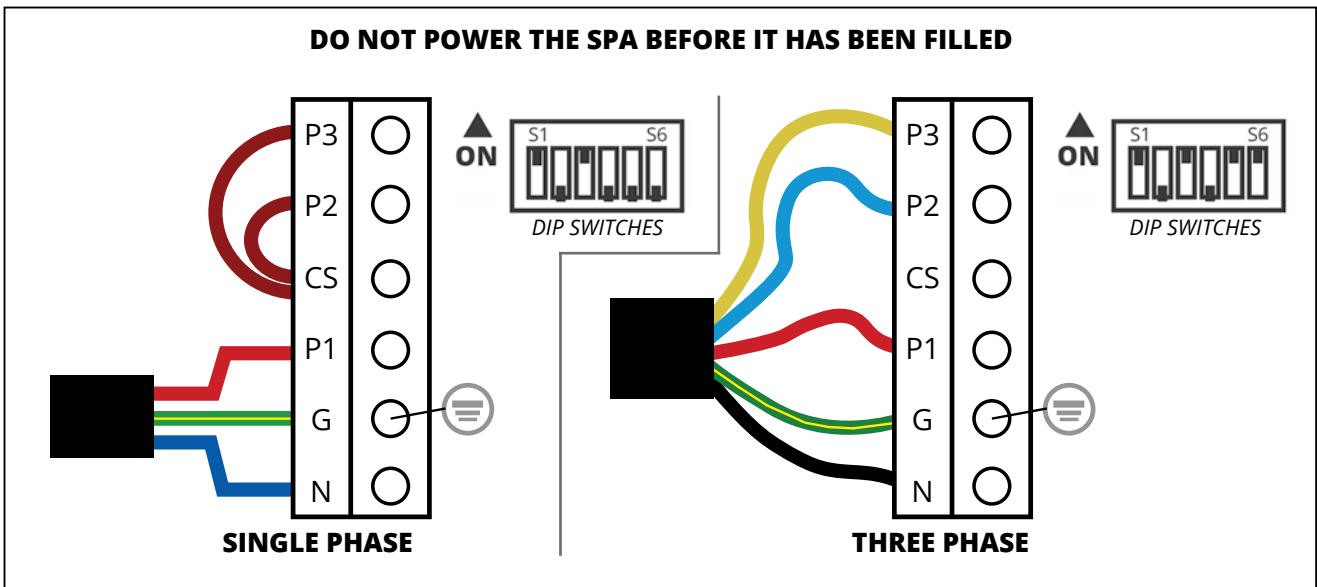

To setup for high amp (45A, no load shed*) see page 17 for information.

Locating the Controller

Remove the cabinet panels from the side of the spa pool that houses the controller (see following picture for exact location).





Identify labeled parts on pages 70 - 72

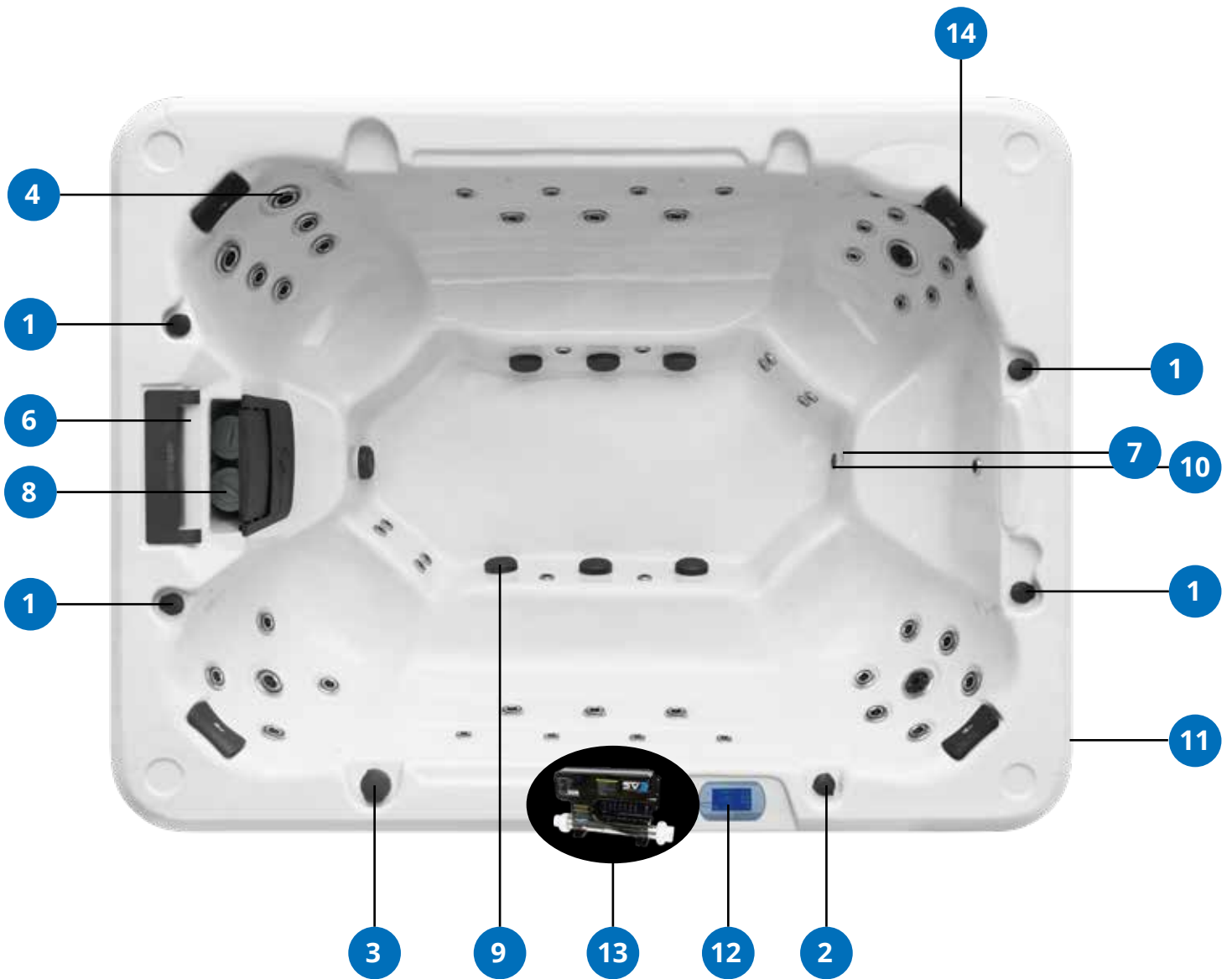

FRONT OF SPA

SPA POOL PARTS LABELED



1 AIR VENTURI

Turning this dial injects air into the jet-stream, boosting the pressure of the jets in a particular set of seats (usually the ones closest to the dial). Turn dial off when finished with the jets to avoid a continuous flow of cold air entering the water when you are not soaking.



2 WATERFALL CONTROL DIAL

This smaller three pin valve is used to adjust the flow rate of the waterfall and fountains (if equipped). To turn off - simply twist clockwise until fully closed and reverse this process to turn on. Be careful not to overturn the dial and force it past its natural stopping point.



3 PRIMARY DIVERTER

This dial gives you the ability to force maximum jet pressure into a certain group of seats. Turn it fully left or fully right to transfer water pressure between different seats in the spa pool. Position it halfway (50/50) to distribute an even pressure to all seats at once.



4 MASSAGE JETS

Stainless Steel bearing-less jets come in a variety of sizes and configurations in your spa pool to deliver a range of different massage pressures to those persons soaking. Activate by turning on the jet pump via the topside control panel.

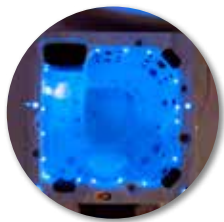

5 LED PERIMETER LIGHTING

There is a perimeter of mini LED lights surrounding the top inner edge of the acrylic. These can be switched between various colour options and modes by using the topside control panel. The LED line is a good indicator of how high your water level should be. Select models.



6 LED WATERFALL

A back-lit waterfall produces a steady stream of water and illuminates with the colour of the chosen LED setting. This can be turned on and off using the waterfall control dial. Select models.



7 LED FLOODLIGHT

A large LED floodlight sits below the waterline, tinting the water to the selected LED colour while syncing with the rest of the lighting package.



8 SKIMMER BOX

The skimmer box houses your filter(s) which water is drawn through when the circulation pump is engaged. (Floating weir skimmer pictured, see pages 12-13 for model specific skimmer box examples).



9 PUMP INTAKES

Pump intakes sit in the foot-well of the spa pool. Water is sucked through these by the pumps and then expelled back out the jets.



10 INTERNAL DRAIN

The spa pool water drains out this port when the external drain valve is released. Small Ozone bubbles may emit from this piece from time to time - this is a normal function.



11 EXTERNAL DRAIN VALVE

The external drain valve sits on a cabinet panel on one side of the spa pool. Attach a hose and twist and turn to release the flow of water when draining. Using the drain valve is explained on page 77.



12 TOPSIDE CONTROL PANEL

This is the button pad and temperature display panel located on the top of the spa pool into which various commands, control sequences and options for operating the spa pool can be entered. (SV-SMART panel pictured)

SPA POOL PARTS LABELED - CONTINUED



13 SYSTEM CONTROLLER

The heart of the spa pool. A computer system and heater makes up the controller as a whole and controls all components in the spa pool including the topside control panel.



14 HEADREST

Select hydrotherapy seats have headrests as a comfort option to add to the relaxation experience. Some headrests have LED lights behind to illuminate the area.



15 CABINET PANEL

Multiple cabinet panels surround the outer edge of your spa pool which protect the components inside. Panels are held on to the frame of the spa pool with vertical slats which sit at each end of the cabinet side.



16 VERTICAL SLAT

The multiple vertical slats hold the cabinet panels to the framing of the spa pool. To remove the panels, undo the screws holding the slats.



PRESSURE DIVERTER & AIR VENTURI VALVES

Pressure Diverter

Found on select models, turning this dial left/right will switch the jet pressure from one side of the spa pool to the other. For even jet pressure across all seats, leave the dial adjusted to the middle position (50/50).



Air Venturi Valve

Turning these dials on will inject air flow into selected jets to increase their pressure. You will notice the water stream becomes aerated when functioning. The seat located closest to the dial is usually the one to receive the boost. We recommend to turn off these valves when you exit the pool.



WATERFALL CONTROL (SELECT MODELS)

Waterfall Behaviour

The waterfall will only flow when the circulation pump is running (heating or filtering) and when the dial is open. See your Spa pools model overview to help locate the dial.



Turning ON/OFF

Turn the waterfall dial anti-clockwise to open the flow of water, clockwise to shut it off. Be EXTREMELY careful not to over-twist and push the dial past the point of natural resistance.



LED LIGHTS

Activating the Lights - SV SMART & SV MINI PANELS

Activate the LED lights by pressing the 'LIGHT' button found on the top-side control panel. Once pressed you can change the modes by using the 'UP', 'DOWN' and 'OK' buttons to select desired option.



LIGHT

UP

DOWN

OK

Activating the Lights - SV3 PANELS

Activate the LED lights by pressing the 'LIGHT' button found on the top-side control panel. Change the modes by pressing the 'MODE' button, and then using the 'UP', 'DOWN' and 'OK' buttons to select desired option.



LIGHT

MODE

SPD/CLR

UP

DOWN

OK

JETS

Activating the Jets

To turn on a jet pump - press the jet button/s on the top-side control panel.



Jets

Adjusting Jet Water Flow

Each individual jet piece can have its water pressure adjusted by opening and closing the flow. For max pressure, simply turn the jet face gently in an anti-clockwise direction until you feel it stop. To reduce/stop the flow, turn in a clockwise direction. When closed, a small amount of water trickling through the jet piece is normal (this is protection for the pump in case all jets pieces are shut off).



Twist jet clockwise to close flow.



Twist jet anti-clockwise to open flow.



Removing the Jets

You will need to remove the jet pieces to clean behind them (It's easier to remove a jet piece when the spa pool is empty, however it is possible to do when filled). Ensure the jet pump is off before attempting to remove any jets.



1 Grip the jet piece tight and turn in an anti-clockwise direction.



2 When you feel the natural stopping point, apply slightly more turning pressure while gently pulling towards you.



3 The jet piece should pop out and be able to be removed, exposing the jet body.

To replace the jet piece, reverse the steps above and turn in a clock-wise direction.

Interchanging the Jets

Jets of the same size mold can be swapped around to build custom seats. Choose the desired jet pieces to interchange and follow the removal and replacement steps above.

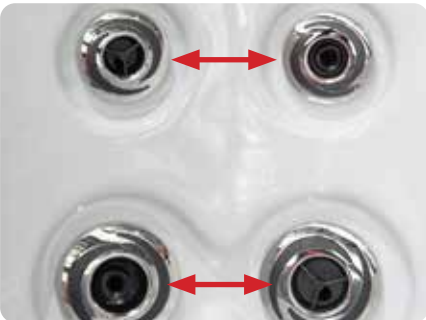

Jet pieces of the same size can be interchanged

OPENING THE PANELS



OPENING THE SPA POOL PANELS IS A WARRANTY REQUIREMENT.

Your spa pool contains high performance parts that are regularly put under pressure and exposed to various water conditions controlled by the user. As part of your warranty requirements, your spa pool requires periodic checking of the components inside, just like how a car requires the bonnet opened to check oil.

The inspection is rather simple and should take no longer than 10 minutes.

See pages 84-86 to understand what to check for.



Each side of the spa pool consists of two cabinet panels, left and right, which meet together in the middle with tongue and groove fitting. Holding these panels onto the frame of the spa pool are two vertical slats at each end with 3 screws per piece. Two extra screws are installed in the middle of the right hand panel (screws are marked in red in above diagram). Note: *Front panel has an LED logo which two small lights LED lights connect into from the back. Take care when removing the front panel and simply pull the LED lights out of their sockets to disconnect.*

To remove the panels:

1. Start by unscrewing the vertical slats from each side. (Phillips size 3 bit is best).
2. Unscrew the two middle screws at the middle.
3. The panels should come away from the cabinet, if not, push down and/or pull towards you.
4. Reverse the steps to replace the panels.



DRAINING THE SPA POOL

Operating the Drain Valve

When it's time to drain the spa pool you can use the simple external drain valve mechanism located on the bottom edge of your spa pool. Water will not flow out of the drain as long as the cap is on tight and pressed in as per the 'flow locked position' - see photo. To use the drain valve, follow the steps below.



Flow locked
(Retracted Position with cap screwed on tight)

Draining Water

Your spa pool needs to be drained and refilled every 3-4 months depending on usage. This is outlined in more detail in the 'Spa Pool Water Care Handbook' found in your iPack (and online on our support page), along with accessories to help drain the water.



TURN OFF POWER TO THE SPA POOL BEFORE DRAINING THE WATER!



1

Start with the drain in the 'Flow locked' position (retracted).



2

Extend the inner drain valve by pulling on the drain cap all the way out as far as shown in next image.



3

Unthread the drain cap and remove it.



4

Screw on a male-end hose attachment.



5

Attach your hose and run the end to a drain location.



6

Push the drain valve slowly in towards the spa to the 'half way' point. Check that water flows from the hose and adjust (push in or pull out slightly) if necessary.

CLEANING THE FILTERS

We recommend having a second set of filters on hand to rotate while cleaning.

Quick Clean (once per week)

Once a week, remove your filters from the spa pool and wash them down with a hose. Maximize the water pressure of your hose and spray the cartridge thoroughly (put your thumb over the tip of the hose). Your aim is to remove any build up of filtered material stuck between the folds of the filter paper. Do not leave filters out of spa pool for prolonged periods of time.

Soak Filters (once per month)

Once a month, remove your filters from the spa pool and place them in a bucket of warm water. Add filter cleaning solution to the bucket (available from Alpine Spas) and leave to soak overnight. Once soaked, remove from bucket and wash thoroughly with a hose to remove loosened debris and all of the cleaning solution - this will help prevent foaming.

Replacing Filters (as required)

A filter cartridge should last up to 6 months when cleaned as per this guide. Filters that are discoloured and become difficult to clean are signs that a new set may be due. Only Alpine Spas approved cartridges are to be used in the spa pool.

CLEANING THE ACRYLIC SHELL

General Cleaning (as required)

The acrylic surface is non-porous and most marks or dirt should come off quickly and easily. We recommend using a microfibre cloth to wipe the shell. For more resistant marks you can dissolve a small amount of baking soda into the cloth and apply it to the targeted area.

From time to time a ring (sometimes referred to as scum ring or tide line) may appear just above the waters edge. A wipe with a microfibre cloth will take care of this, but good water balance will generally prevent this from occurring in the first place. Check your water care handbook for advice.

Cleaning When Draining (every 3-4 months)

When doing your 3-4 monthly drain and refill, it's a good chance to fully wipe down the acrylic shell. Use some baking soda or a low-strength all purpose cleaner and wipe everywhere with a microfibre cloth, including around the jets (you may want to pop them out to get in behind them).

Hose down the spa pool interior once finished and drain or bucket out the water at the bottom. You want to avoid refilling with the leftover remains of your cleaning solution as this may foam or cause trouble when trying to balance the water upon refilling.



CLEANING & MAINTAINING THE CABINET

The synthetic cabinet (composite wood) is virtually maintenance free, however you should hose it down once a month or as required to remove any cobwebs or dirt accumulating. A mild soap and microfibre cloth could be used to assist if required for stubborn marks, as long as it is thoroughly washed off.

A cedar cabinet can be washed down and scrubbed with a soft brush if required. To prevent natural silvering of the cedar over time and to protect from cracking and splitting, a U.V protectant oil should be applied every 6-12 months.

CARING FOR THE SPA POOL COVER

The cover consists of a shrink-wrapped polystyrene block wrapped in a marine-grade UV treated outdoor vinyl. Although it's tough and made to withstand the elements, the cover is continually exposed to harsh sunlight and weather conditions plus whatever else is thrown at it during day-to-day usage. To maximize its life-span, please follow these guidelines:

General Cleaning (as required)

Keep your cover as clean as possible, and remove any debris that may build up on top of the vinyl. Wipe with a microfibre cloth or large towel and hose down if required. Wipe the underside of the cover regularly.

Dedicated Clean (once per month)

Once a month, completely remove the spa pool cover from the spa pool (you may want to cover the spa pool with a tarp or similar protector during this process). Thoroughly clean both the top vinyl and underside of the cover using warm water and mild dish-washing detergent (do not use harsh chemicals). Hose off and dry the cover with a towel. Ensure you clean the locks and straps so they are free of any mold or cobwebs. Unzip a portion of the zip and in a safe place, stand your cover up to form an 'A-frame' and leave to dry like this for 1-2 hours before placing back on top of your spa pool.

Protecting the Vinyl (every 3-4 months)

Every 3-4 months or each time you go to drain your spa pool, it's a good chance to apply a vinyl protector to the topside of the cover. A spray on solution such as '303 Aerospace Protectant' (available from Alpine Spas) with U.V protecting properties or similar would be sufficient. Dry cover and remove any dirt before applying. A light coat will bring the colour back to life and help your cover stand the test of time.

Note: Consider purchasing a cover lifter if you haven't already. These units increase the life span of the cover by keeping it suspended off the ground and tucking it neatly behind the spa pool when it is in use.

CLEANING THE JETS

Turn the spa off temporarily. Remove the jet pieces (can be done while filled) from the body (see page 74) and clean them in a bucket of water. Use a brush if required to remove any build up of calcium or grime. Clean inside the jet body if required. Inspect the plastic backing - any sign of corrosion (flaking or peeling) please contact Alpine Spas as this is an indication of poor water quality and low/high levels of pH or alkalinity. Rinse jets thoroughly in fresh water before reinstalling.

PERFORMING A PIPE CLEAN

Consistent water balancing and general filter cleaning will keep your water clean and clear and protect your spa pool components. But unfortunately it's almost impossible to avoid bacteria and organic material making a home inside the spa pool plumbing/ pipes.

Bacteria has a way of protecting itself by forming as 'bio-film' which sticks to the inside of the pipes. Although this rarely causes issues, excessive build up can make water balancing more difficult and you may find bits of bio-film floating in the spa pool if some of it manages to detach from the interior pipe wall.

To destroy bio-film or any other nasties hidden in the pipes, we recommend that you do a 'Pipe Clean' by regularly adding Iluka Brilliance. Customers can purchase these from www.spasupplies.co.nz in New Zealand, spasupplies.com.au in Australia or at an Alpine Spas showroom. If you add Iluka Brilliance to your spa water every month it will help keep your pipes clean and clear of any bio-film.

Once you have added **Iluka Brilliance** to your spa water, simply press the 'CLEAN' button on your spa to ensure that all of your pumps are activated at least once. This will ensure it can circulate and clean all of the pipes.

If you haven't added **Iluka Brilliance** to your spa water for a while, you may find that a significant amount of bio-film is dislodged from your pipes. It's important to clean your filters after doing so - this will prevent the bio-film from sitting in your filters and circulating bacteria throughout your spa.

People who use **Iluka Brilliance** often report that they notice their spa water quality improves noticeably. The great thing about this product too is that you can add it to the spa water and it's safe for you to get in the water straight away.

Please note: Using Iluka Brilliance does not remove the need to regularly use a sanitizer, balance your water's PH, Alkalinity and shock dose your spa water.



LEAVING THE SPA POOL SHORT TERM

Leaving your spa pool, whether for short term or an entire season, demands proper care to ensure its longevity and optimal functioning upon your return. Correctly preparing your spa for hibernation is crucial to avoid potential damage to its components. This guide will walk you through the essential steps for safeguarding your spa during periods of non-use.

1. Clean Filters

Your spa pool operates best with a clean set of filters. Remove and wash thoroughly as per filter cleaning instructions on page 78.

2. Remove Headrests

Unclip the headrests and dry off before putting them in a safe place. When the cover stays on the spa pool for an extended period of time, ozone gas can build up on top of the water and eat away at the headrest material.

3. Shock Dose

Fortnightly shock dose the water using the appropriate amount of 'Spa Chlorine' for your spa pool and ensure the cover is left off for 1 hour while running the pumps before replacing it.

4. Turn Down Temperature

Turn the temperature down as low as it can go, or place in away mode and make sure the spa pool is set to operate its filter cycles automatically (this is the default).

5. Secure Cover

Place the spa pool cover on securely and lock with the clips.

By following those steps your spa pool will keep filtering and will not heat excessively while you are away. You will return to a healthy, clean spa pool. If possible, while you are away, have a neighbour or friend open the spa pool cover once every week to air it out for 1 hour and do a shock dose as per step 3.

TURNING OFF LONG TERM WHILE UNATTENDED

For some spa owners, the prospect of leaving their beloved spa unattended during a hibernation phase might be daunting, especially if there's no reliable support from family, friends, or neighbors to assist in periodic maintenance. If you can't guarantee you or someone can regularly maintain the spa during the hibernation period, this guide will walk you through the essential steps for safeguarding your spa during hibernation while it's left unattended.

1. See Previous Steps

Perform steps 1 and 2 from 'Leaving the Spa Pool Short Term' before moving on.

2. Turn OFF Spa Pool

Completely turn off the spa pool at your isolation switch or mains board.

3. Drain the Water

Drain the water out of the spa pool via the external drain valve.

4. Drain pipes via Barrel Unions

Open up the cabinets surrounding the spa pool and locate the barrel unions at the controller unit / heater and the pumps. Loosen (strop wrench may be required) the barrel unions either side of the component to drain excess water from the surrounding pipes. Put down a towel if required, to soak up water. Tighten the unions back up once finished.

5. Blowout Pipes (recommended if switching off for 6+ months)

Climb inside the spa pool with a 'Wet-Vac'. Remove the jet pieces and place the vacuum nozzle into the jet body to suck water directly out of the pipe. Not every jet piece needs to be attended to, aim for 3-4 per seat. Other pipes to suck water from are the internal drain valve and the circulation jet mounted on the side of the spa pool acrylic (usually near the topside control panel).

6. Wash Jets

Remove the jets from the spa and rinse them with fresh water. Then wipe the jets clean and dry before putting them back into the spa.

7. Wipe Down Spa Pool

Remove any excess build up of water from inside the spa pool and wipe the acrylic shell down completely with a microfibre cloth and mild all-purpose antibacterial Spray.

8. Secure Cover

Place the spa pool cover on securely and lock with clips. Cover entire spa pool with a tarp or 'spa pool winter cover' for the best long-term protection.



CLEANING & MAINTENANCE SCHEDULE

Follow this easy cleaning & maintenance schedule to care for your Spa Pool and help protect your warranty.

WEEKLY

- Test and balance the water
- Clean filters (quick clean process)
- Shock dose
- Wipe down cover, cabinet and acrylic as required.

MONTHLY

- Clean filters (soak process)
- Clean cover (dedicated clean process)
- Rinse headrests in fresh water

EVERY 3-4 MONTHS

- Remove, inspect and clean jet pieces
- Wipe down acrylic shell while water is drained
- Protect cover (apply vinyl protectant)
- Open panels. Inspect components.
- Inspect pumps, check barrel unions and U.V Bulb
- Drain and refill process (pipe clean if required)

PUMP MAINTENANCE

You must check the pumps inside your spa pool on a regular basis to ensure they are operating as efficiently as possible and there is no leaking or corrosion occurring. Issues with pumps, particularly seal corrosion, is generally caused by incorrect pH and alkalinity levels or excessive dosage of sanitisers such as chlorine or bromine.

Maintaining/balancing the spa pool water according to well established methods and following the guide provided will help to avoid such issues.



ISSUES OUTLINED ABOVE ARE NOT COVERED BY WARRANTY.

How to check your pump(s)

We recommend checking the pump(s) every 3-4 months which should become part of your drain and refill process. The number of pumps will vary per spa pool, so check your spa pool overview page.

Open up the cabinets around the spa pool to find the pump(s). Any signs of leaking, rust, calcium build-up or yellow/white powder type substance usually between the plastic wet end and metal parts of the pump may indicate an issue and service may be required. Please photograph and contact Alpine Spas.

BARREL UNION MAINTENANCE

Barrel unions are the connection piece used to join the plumbing to the pumps and the heater. Being able to easily remove the pumps or heater is important for servicing.

Because barrel unions are a thread fitting, they may loosen slowly over time due to factors such as vibration (from the pump) and need to be checked periodically. Loose barrel unions will promote leaks.

How to check your barrel unions.

Open up the cabinets around the spa pool. Find the pump(s) and the system controller (this unit houses the heater) and you will see the white barrel unions which sit at either end of the component (pump, heater etc). Check to see if they need to be tightened and if so, grip and turn clock-wise to tighten.





UV SYSTEM BULB REPLACEMENT

It is a requirement of the owner to change the Ultra-Violet light bulb (if equipped) every 12 months, however like any light-bulb, there is a chance the bulb could fail before its expected lifetime is up. If this is the case, you can see this light in the Alpine Spas logo on the outside of the panel - it will have changed from green to red. Check for this light when performing your 3-4 monthly component inspection as per page 83.

Contact Alpine Spas to purchase a new U.V bulb - the bulb carries a 12 month parts warranty.

A replacement can be installed in a number of minutes without needing to drain the spa pool. Please follow our video or photo guide found on our support page (see link at the bottom of the page).

TECHNICAL SUPPORT CONTACT

If reading through this manual and following the solutions from the troubleshooting guide has not resolved your issue, please contact Alpine Spas:

EMAIL

**service@alpinespas.co.nz or
service@alpinespas.com.au**

**PHONE: 0800 99 33 88 (NZ)
or 1800 99 33 88 (AU)**

SELECT TECHNICAL SUPPORT FROM THE OPTIONS



Find support documents and guides on our website at:
www.alpinespas.co.nz/support or www.alpinespas.com.au/support

TROUBLESHOOTING

Water Troubleshooting

Please see our 'Spa Pool Water Care Handbook' for a complete guide of troubleshooting water issues. See page 21 for more information.



Download the handbook from the support page on our website:
www.alpinespas.co.nz/support or www.alpinespas.com.au/support

General Troubleshooting

ISSUE	POSSIBLE CAUSE	SOLUTION
Display is blank	Data connection failed	Switch Spa pool OFF and ON again
No power	Breaker or RCD OFF Loose plug or wires	Check RCD is turned on Check plug & wire connections (electrician)
RCD trips	Mis-wired connections Component failure	Check wiring is correct & matches diagram (electrician) Call for service
Spa pool NOT heating	Spa pool in rest/away/sleep mode Temp set low	Change mode to ready/normal mode Increase set temperature
Spa pool doesn't reach set temperature	Spa pool in rest/away/sleep mode	Change mode to ready/normal mode
Low jet pressure	Jets closed 2-Speed Pump in low speed	Turn jet face anti-clockwise to open. Press jet button again to enter high speed
No jet pressure	Air-lock in plumbing	Turn off power to spa for 30 seconds and then turn it back on. Bleed pump by loosening the barrel union
Spa pool is leaking / water appears on ground around cabinets	Leaking from barrel union Leaking from corrosion	Check & tighten barrel unions on pumps & controller Contact Technical Support



Diagnostic Messages - Topside Control Panel

MESSAGE	CAUSE	ACTION REQUIRED
ER-2 HEATER PLUG (no heat sensor communication)	Internal heater sensor communication error	Turn mains power OFF, wait 5 minutes then restart spa pool. Contact tech if problem not resolved
ER-3 WATER PRIME (prime has failed)	Air detected in heater tube Low water level Dirty filter cartridges Airlock in pipe work Slice-valves shut	Turn off power to spa for 30 seconds and then turn it back on. Check spa pool water level (refill if necessary) Remove and clean filter cartridges then press Pump A button to retry prime Bleed air from pipes by loosening barrel unions on pumps Check all slice valves are open
ER-4 THERMAL TRIP (Heater thermal trip activated. Heater has been active & has had insufficient water flow over the element. Low or no water flow has caused the heater temperature to exceed its maximum limits & the spa pool control has shut down operation to prevent any damage to the heater unit)	Low water level Airlock in pipe work Dirty filter cartridges Slice-valves shut	Check spa pool water level (refill if necessary) Bleed air from pipes by loosening barrel unions on pumps Remove and clean filter cartridges. Turn off power to spa for 30 seconds and then turn it back on. Check all slice valves are open
ER-5 POOL TOO HOT (Water temperature too high, sensor reading +45 degrees)	High ambient temp (summer) Excessive filtration time	Turn off spa pool, remove cover and allow water to cool before switching back on. Reduce filtration time
ER-6 12V OVERLOAD	12V port current draw exceeding 1A limit	Call for service
ER-8 CTRL FAULT HVS (heater relay on when it should be off)	Power Surge Periods of low/high voltage Water on controller terminal	Turn mains power OFF & back ON again. Inspect inside spa pool cabinet for leaks or evidence of water exposure to controller. Turn off spa pool, dry water/fix leak and let controller dry out
ER-10 OVER CURRENT (Mains 230v current draw above current limited C.LMT detected)	Components current draw too large for C.LMT setting	Power OFF/ON. Check C.LMT / L.SHD / L.LMT settings are correct. Do elimination test on components using the control panel to identify which connection is causing the fault

NOTES

A series of horizontal dotted lines for writing notes.



A series of horizontal dotted lines for writing, spaced evenly down the page.



NEW ZEALAND



www.alpinespas.co.nz



0800 99 33 88



service@alpinespas.co.nz

AUSTRALIA



www.alpinespas.com.au



1800 99 33 88



service@alpinespas.com.au